



Moodyville

East 3rd Street Area
Development Permit Area Guidelines

This page intentionally left blank

Contents

Part I – General Regulations

1	Introduction	
1.1	Intent and Use of the Guidelines	2
1.2	Guiding Principles	3
1.3	Neighbourhood Subareas	5
2	Approval Process	
2.1	Application	9
2.2	Exemption	9
2.3	Submission Requirements	10
2.4	Amendment	10

Part II – Conservation Guidelines

3	Energy Conservation	
3.1	Enhanced Energy Standard	11
3.2	Renewable Energy Generation	11
4	Water Conservation	
4.1	Permeability	12
4.2	Rainwater Retention	13
5	Reduction of Greenhouse Gas Emissions	
5.1	Vehicle Charging	14

Part III - Form and Character Guidelines

6	Site Planning	
6.1	Building Forms	15
6.2	Orientation	17
6.3	Special Conditions	18
6.4	Courtyard	19
6.5	Building Scale	20
6.6	Grade	20
7	Building Envelope	
7.1	Setback	23
7.2	Length	25
7.3	Depth	26
7.4	Height	27
7.5	Separation	28

8	Building Design	
8.1	Design Variation	30
8.2	Materiality	31
8.3	Entrances	32
8.4	Windows	33
8.5	Balconies	34
9	Open Space and Access	
9.1	Interface	35
9.2	Open Space	37
9.3	Landscaping	37
9.4	Safety	39
9.5	Vehicle Parking	40
9.6	Service Infrastructure	41

Part III - Appendix

10	Drawings	
10.1	Overview	42
10.2	RG-3 1.00 FSR Townhouse upslope of street	43
10.3	RG-3 1.00 FSR Townhouse downslope of street	44
10.4	RG-3 1.00 FSR Townhouse fronting East 3 rd Street between Ridgeway Avenue and Queensbury Avenue	45
10.5	RG-4 1.25 FSR Stacked Townhouse	46
10.6	RM-2 1.60 FSR Back-to-back Stacked Townhouse with live-work frontage	47
10.7	RM-2 1.60 FSR Apartment	48

Part I – General Regulations

1 Introduction

These guidelines apply to residential development applications in the Moodyville neighbourhood in the City of North Vancouver. The Official Community Plan 2014, No. 8400, (OCP) establishes the East 3rd Street Area Development Permit Area (DPA), known as Moodyville, to respond to sustainability concerns, design issues and local context. In conjunction with related amendments to the Zoning Bylaw 1995, No. 6700, the Moodyville guidelines provide opportunities for a range of ground-oriented multifamily housing types in proximity to employment, services and schools.

This area has long served as a focus on the North Shore. For centuries prior to the arrival of European explorers, First Nations permanent villages and seasonal encampments established historical and spiritual ties to these lands that continue today. The multicultural company town that would become known as Moodyville was founded in the mid-19th century, predating development along Lonsdale Avenue to the West.

The neighbourhood continues today to be characterized by its south-facing slope towards the shoreline, quiet streets and interrupted views of Burrard Inlet and the City of Vancouver skyline beyond. The multiuse Spirit Trail crosses Moodyville, connecting Lower Lonsdale, the Squamish Nation and other communities across the North Shore. The neighbourhood overlooks the Port Metro Vancouver industrial waterfront, a principal element of the City's and region's economic profiles, a leading employer, and a contributor to local infrastructure and services. Grain elevators and other port infrastructure are the dominant built elements.

It is this context that serves as the foundation for the next chapter in Moodyville's narrative. With the community's participation, these guidelines have been developed to advocate for a welcoming and attractive neighbourhood. They illustrate multifamily development that frames local, tree-lined streets. A range of building forms and housing types create a diverse streetscape, unified by the pedestrian-scale rhythm of front doors with paths to the sidewalk. Lanes and greenways further promote a living streets approach with fine-grained access through the neighbourhood. Buildings follow the natural slope, and considerations of view impacts and neighbourliness temper the apparent scale of development. Contemporary architectural forms support placemaking and comfort through well designed frontages and enhanced energy efficiency, noise reduction and adaptability.

The Moodyville guidelines will support efforts to increase family-friendly housing in the community through designated densities that allow for a diversity of ground-oriented townhouse and low-rise apartment housing forms. Buildings are commonly arranged around a courtyard, and, in almost all forms, each dwelling benefits from a front door opening onto the street, lane or mews. The topography contributes to the ability of stacked townhousing to maintain a ground orientation. In conjunction with the City's Active Design Guidelines, outdoor and common area design emphasize the social interaction and neighbourliness often associated with townhouse forms. Finally, housing diversity is supported through a mix of unit sizes and the introduction of rental lock-off units to enhance the ability of a dwelling to meet a family's needs as they change over time.

These guidelines reflect an opportunity to introduce new types of ground-oriented housing into the City and to create a model for transit-oriented and energy efficient development. They support a neighbourhood identity shaped by parks, greenways and paths, proximity to the Lonsdale Regional City Centre and the future rapid transit corridor.

1.1 INTENT AND USE OF THE GUIDELINES



Development Permit Area guidelines allow for more detailed consideration of development, and they provide additional certainty of the form and character of new buildings to the benefit of owners, neighbours and the broader community. A focus of the Moodyville guidelines is encouraging a pedestrian-friendly and transit-supportive environment. Moodyville is part of a Metro Vancouver identified Frequent Transit Development Area centred on a future rapid transit corridor. Development in Moodyville will contribute to transit investment by delivering a widened transit corridor, enhanced streetscape and greenway network. This public realm will help to define the neighbourhood and to encourage a range of active uses.

These guidelines also promote energy and water conservation as well as the reduction of greenhouse gases (GHG). In addition to encouraging a range of transportation options, Moodyville is expected to be a model of passive design with new buildings demonstrating energy savings and GHG reductions through enhanced envelope performance and decreased reliance on mechanical systems for building comfort. Landscaping guidelines seek to create attractive and productive gardens and boulevards and to implement progressive strategies to manage stormwater and to conserve water.

Development Permit (DP) applications are reviewed against these Guidelines by staff and the Advisory Design Panel. Most applications will require revisions prior to DP issuance. Applications that fail to comply with the guidelines will be required to apply for a Development Variance Permit or Rezoning. This process will require additional time to allow for a Public Meeting or Public Hearing to inform Council's decision.

The identity of Moodyville is enhanced through the collective influence of existing and future residents of this neighbourhood. Applicants and designers are asked to consider the appropriate size and massing and the potential impact on neighbours.

The Moodyville guidelines should be considered in conjunction with the Zoning Bylaw and other City regulations. Contact staff for consolidated materials created for the convenience of applicants.

1.2 GUIDING PRINCIPLES

The following principles, identified through community consultation, direct the Moodyville Guidelines. Each principle is followed by related strategies that address the challenges and opportunities for the Moodyville neighbourhood.

Contribute to Moodyville identity

- Foster a distinct sense of place with contemporary forms and innovative design;
- Vary architectural expression across large assemblies to support the appearance of incremental development;
- Reflect the North Shore setting and preserve mature vegetation; and
- Incorporate durable and local building materials.

Create neighbourly streetscapes

- Respond to shadowing and overlook impacts;
- Emphasize a rhythm of individual units with visible front doors and porches; and
- Encourage social interaction on safe and active streets and lanes.

Advance sustainability

- Create a model energy efficient neighbourhood;
- Demonstrate innovative rainwater management;
- Support universal access and active design approaches;
- Create resilient infrastructure for both new and existing housing; and
- Use streets for landscaping and gardening.

Improve mobility

- Support a strong East 3rd Street transportation corridor;
- Enhance the small scale residential pattern through pedestrian connections;
- Create welcoming and pedestrian-friendly lanes;
- Frame streets with buildings and design to encourage safe vehicle speeds; and
- Highlight greenways that offer convenient, safe and enjoyable access to parks and other services.

Promote housing diversity

- Build a range of housing;
- Encourage flexibility to respond to families' changing needs;
- Provide amenities to support seniors, children and youth; and
- Encourage neighbourliness with semi-public and public spaces.



Figure 1. **East 3rd Street corridor**



Figure 2. **Neighbourhood centre**



Figure 3. **West of St. Patrick's Avenue**



Figure 4. **400-block transition**

1.3 NEIGHBOURHOOD SUBAREAS

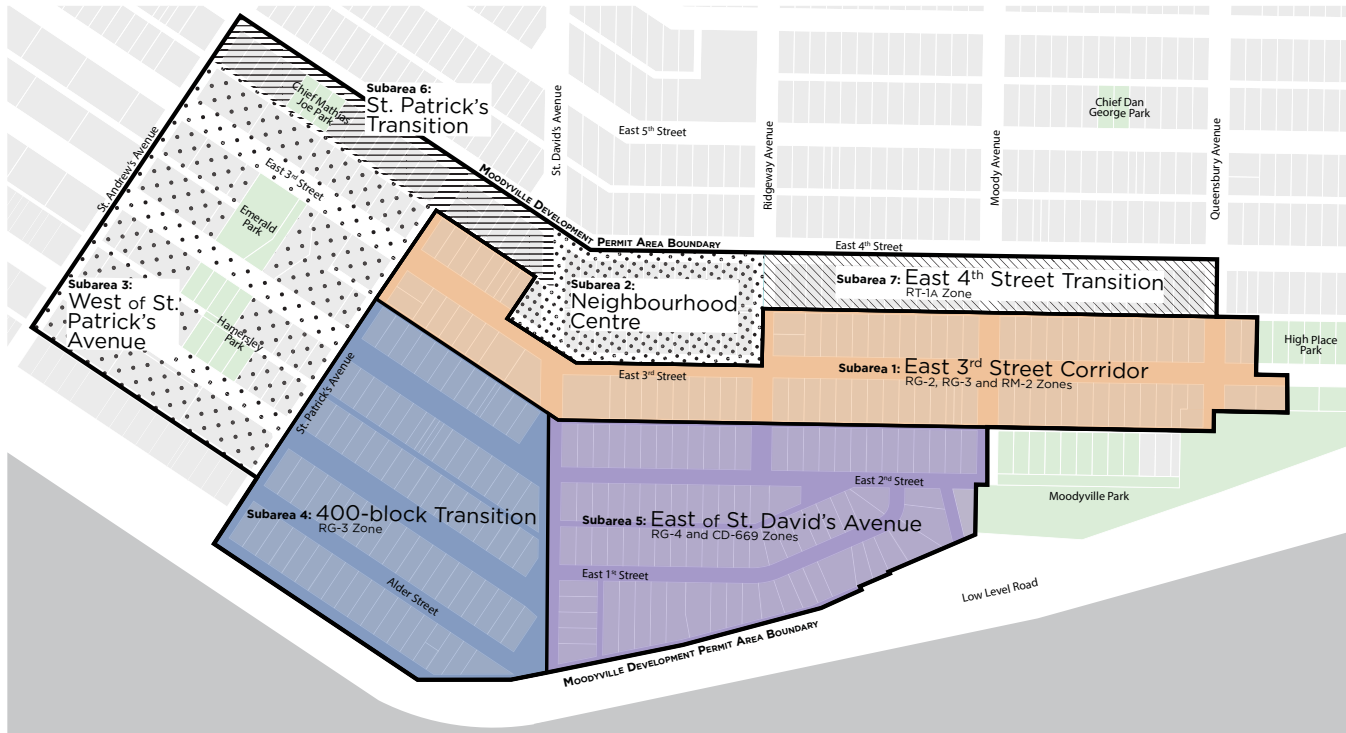

Figure 5.

Moodyville subareas

The Moodyville Development Permit Area is divided into a number of subareas (Figure 5). The land use designation, building forms and context suggests a unique response for each of these multi-block areas, and the Moodyville neighbourhood will be defined by the sum of these Development Permit Area identities. These guidelines apply as indicated above, meaning that they do not apply in Subarea 2 (Neighbourhood Centre), Subarea 3 (West of St. Patrick's Avenue), Subarea 6 (St. Patrick's Transition) and Subarea 7 (4th Street Transition). These subareas are subject to other Development Permit Area guidelines as described below.

Subarea 1: East 3rd Street corridor (RG-2, RG-3 and RM-2 Zones)

Development along East 3rd Street will reflect its role as part of the future rapid transit corridor connecting Ambleside town centre in District of West Vancouver and Lynn Creek town centre in the District of North Vancouver (Figure 1). Lonsdale Avenue is the only other corridor identified to support rapid transit in the City. Dedication sufficient to create a 30.5-metre (100-foot) wide corridor is required in the Moodyville area to facilitate the creation of the rapid transit corridor. This width accommodates future vehicle loads and dedicated transit lanes as well as the generous sidewalks, boulevards and street trees expected in the public realm for an important corridor in the City.

The land use designations and building envelopes reflect the widened road with a 3:1 ratio of building separation across East 3rd Street to building height. The scale of development and landscaping expectations support a pedestrian scale that reinforce the increased activity resulting from ongoing transit investments. The Moodyville Guidelines encourage live-work use on nearby frontages. Major greenway crossings connecting the Spirit Trail and Green Necklace highlight two intersections: St. David's Avenue at the neighbourhood centre and Queensbury Avenue at the entrance to Moodyville Park.



Figure 6. **East of St. David's Avenue**



Figure 7. **St. Patrick's transition**



Figure 8. **East 4th Street transition**

Subarea 2: Neighbourhood centre

A commercial or mixed-use centre of the neighbourhood is designated on the north side of East 3rd Street including frontages on either side of St. David's Avenue and between St. David's Avenue and Ridgeway Avenue (Figure 2). Since the guidelines are intended for residential use, they do not apply to this subarea.

Development in this subarea will create a neighbourhood centre by incorporating ground-level retail opportunities and the potential for office or other commercial uses above. The inclusion of commercial use, shift in the street grid and crossing of St. David's Avenue greenway elevates this intersection along the rapid transit corridor as a neighbourhood centre. Future development is also expected to respond to the continuing use of the BC Hydro substation on East 4th Street.

Subarea 3: West of St. Patrick's Avenue

The 300-block between St. Andrew's Avenue and St. David's Avenue includes three-storey, multifamily rental apartments constructed in the 1970s as well as more recently constructed strata-titled properties (Figure 3). These guidelines do not apply to this subarea since it was largely constructed with multifamily uses prior to establishment of the Moodyville guidelines.

Applicants and owners should be aware of the City's Density Bonusing and Community Benefits Policy and its specific consideration of properties with existing rental apartment use. The Official Community Plan identifies a Residential Apartment Levels 5 & 6 Development Permit Area to guide the form and character of multifamily residential development citywide. Future applications for development in this subarea will be subject to these guidelines once adopted by Council.

Subarea 4: 400-block transition (RG-3 Zone)

Moodyville between St. Patrick's Avenue and St. David's Avenue is defined by the reorientation in the street grid (Figure 4). This block has served for several decades as the transition from the higher density characterizing the blocks to either side of Lonsdale Avenue and the surrounding single family neighbourhoods. West of this block is a mix of industrial and commercial uses towards Esplanade with a range of multifamily housing upslope. Until the 1950s, a large estate with limited development was to the East.

The street is characterized by the wide dedication that is familiar to Lower Lonsdale, but with the large front yard setbacks and reduced building scale of the lower density neighbourhood. New development will introduce reduced building setbacks to define a boulevard edge and to contribute to the active use of the street. Narrowed vehicle travel lanes will support traffic calming. The St. David's Avenue greenway as well as increased permeability of the long blocks south of East 2nd Street will further encourage pedestrian and cycling use. Future street features could include chicanes and community gardens. Reduced road dedications may contribute to neighbourhood amenities and to continue the existing pattern of generous front yards in future multifamily development.

Subarea 5: East of St. David's Avenue (RG-4 and CD-669 Zones)

Similar to its role in the single-family identity of Moodyville following its construction in the 1950s, this subarea is anticipated to have a significant role in the future identity of the neighbourhood south of the rapid transit corridor (Figure 6). It is defined by its narrow road widths. The introduction of townhouse building forms up to four storeys will contribute an urban character to the street, highlighted with sidewalks, boulevards and street trees.

A principal element in this subarea is the Spirit Trail. Although an interim path was completed concurrent with the reconstruction of the Low Level Road, a preferred path that meets the City's All Ages and Abilities standard, including limited grades and separation from vehicle travel, is sought in concert with new development. Extending Ridgeway Avenue and delivering other pedestrian and cycling connections will further enhance the connection of the Spirit Trail and Moodyville. These improvements elevate the foot of Moody Avenue as an important point in the neighbourhood. The reconstruction of Moodyville Park with the Spirit Trail and Queensbury Avenue greenway connections further highlight the eastern park interface of this subarea.

Subarea 6: St. Patrick's transition

East 4th Street between St. David's Avenue and St. Andrew's Avenue has long been established as the southern limit of two-unit residential (duplex) zoning that extends as far north as East Keith Road (Figure 7). Similar to Subarea 3, no land use designation change occurred as a result of the 2014 OCP. As a result, no zoning change nor introduction of a Duplex Development Permit requirement will occur as part of the 2016 Zoning Bylaw amendment and introduction of the Moodyville guidelines.

Subarea 7: East 4th Street transition (RT-1A Zone)

Established single-family neighbourhoods extend upslope of Moodyville east of St. David's Avenue (Figure 8). In support of a transition from low-density residential use to the medium-density residential use framing the East 3rd Street rapid transit corridor, the south side of East 4th Street is designated for duplex use. Developments in this subarea will require issuance of a Duplex Development Permit but will not be subject to these guidelines.

These guidelines present a modified envelope for multifamily use proximate to this area to facilitate a transition from the corridor to the single-family neighbourhood. Similar to other Moodyville subareas, a neighbourly and domestic lanescape is expected, but a reduced building envelope reflects the lower density of the East 4th Street Transition subarea.

2 Approval Process



2.1 APPLICATION

These guidelines apply to all intensive and multifamily residential development within the East 3rd Street Area Development Permit Area (DPA) described in the City of North Vancouver Official Community Plan Bylaw, 2014, No. 8400, Schedule D. This DPA establishes objectives:

- For the form and character of intensive residential or multifamily residential development;
- To promote energy and water conservation; and
- To promote the reduction of greenhouse gas emissions.

The geographic area regulated by these guidelines is Subarea 1,4 and 5, shown for convenience in Figure 5: Moodyville subareas.

2.2 EXEMPTION

Notwithstanding the designation of an area as a DPA, the Local Government Act provides that conditions may be specified under which a development permit is not required. In Moodyville, a development permit is not required in the case of:

- A subdivision which consists of a parcel line adjustment or consolidation where no additional lots are created;
- A subdivision for park purposes;
- An internal alteration (a change or extension in the interior of a building relating to any matter or thing regulated by the B.C. Building Code);
- Temporary buildings or structures that are erected either for offices for construction or marketing purposes for a period that is not expected to exceed the duration of such construction;
- Accessory buildings and structures which do not result in a change to the parking configuration;

- Minor external renovations to existing buildings which do not significantly alter the footprint or exterior character of the building;
- Road or utility works or landscaping within a dedicated road right of way or strata road; and/or
- Green space or trail improvements.

In addition, minor exterior renovations to an existing building which do not significantly alter the footprint or character of the building may be exempted from Development Permit requirements at the discretion of the Director of Community Development.

2.3 SUBMISSION REQUIREMENTS

Every application for a Development Permit must be accompanied by relevant development information in the form prescribed by the City. This information includes, but is not limited to:

- 1) Plans demonstrating the proposed:
 - location of all buildings and structures;
 - siting of parking areas;
 - landscaping and the extent and nature of existing landscaping, including details of trees to be maintained or proposed to be planted;
 - exterior finish, materials, and colour of buildings and roofs;
 - locations of all exterior lighting.
- 2) Detailed description of the compliance of the proposal with environmental guidelines;
- 3) A checklist indicating the compliance of the proposal with the Guidelines. Where some element of the design does not comply with a Guideline, a justification describing the divergence and the reason must be provided;
- 4) Supporting information demonstrating that neighbours within 40 metres (131.2 feet) have been notified.

2.4 AMENDMENT

A Development Permit amendment may be required for minor amendments to Development Permits already issued and registered on title, at the discretion of the Director of Community Development.

Part II – Conservation Guidelines

Development proposals must support the City's commitment to promote energy and water conservation and to reduce greenhouse gas emissions. This requires designing to meet leading building energy efficiency and stormwater management standards and practices. These guidelines refine the City of North Vancouver Subdivision and Development Control Bylaw and Zoning Bylaw regulations.

3 Energy Conservation

3.1 ENHANCED ENERGY STANDARD

Buildings are required to be certified at an advanced energy efficiency standard in accordance with Section 419 of the Zoning Bylaw, utilizing strategies such as those shown in Figure 9.

Guideline 3.1.1 Building designs are encouraged to communicate leading energy conservation principles through a diverse range of architectural responses.

3.2 RENEWABLE ENERGY GENERATION

Guideline 3.2.1 Consider integrating solar energy systems into the architectural design to provide opportunities for renewable generation upon building construction or in the future.

Figure 10

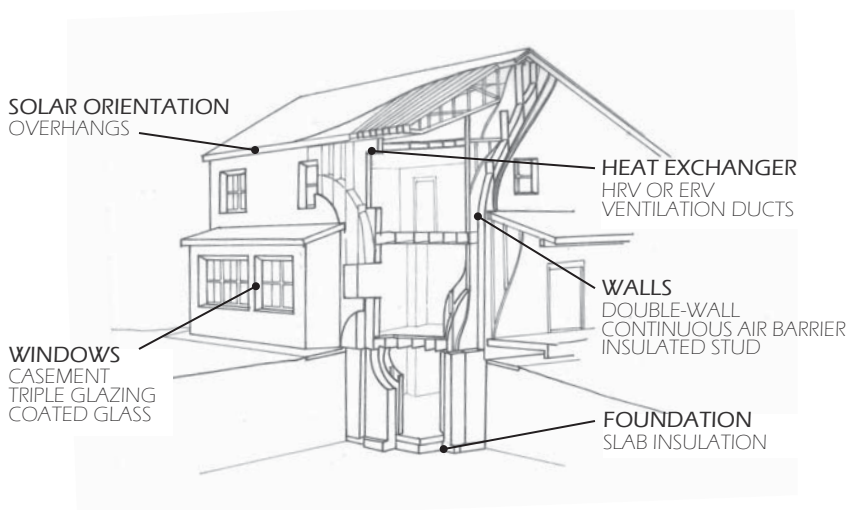

Figure 9.

Advanced energy standard strategies

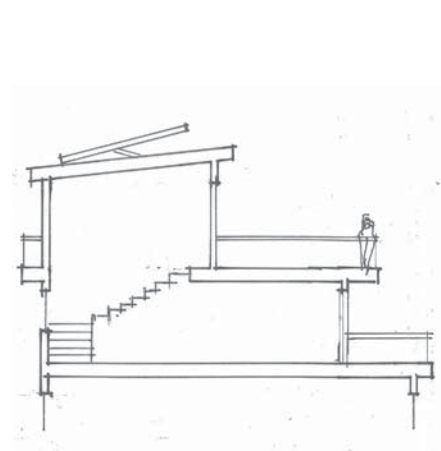

Figure 10.

Integrated renewables

4 Water Conservation



4.1 PERMEABILITY

Developments are required to construct—and to report on—stormwater management works treating water from roads and laneways. This infrastructure must be designed to include allowances for climate change in accordance with the City's Subdivision and Development Control Bylaw.

Guideline 4.1.1 Minimize impervious surfaces through use of the following materials:

Figure 11

- (a) pavers, placed stone or river rock for tree surrounds and areas with infrequent pedestrian use;
- (b) extensive groundcover and planters over parkades; and
- (c) permeable paving for walkways, driveways, exterior courtyard driveways and surface parking, particularly where stormwater discharge into on-site infiltration facilities is not practical.

Guideline 4.1.2 Incorporate on-site landscaping infiltration strategies including:

Figure 12

- (a) finish grading comprised of topsoil or composted waste;
- (b) engineered rock pits and soil cells; and
- (c) visible features such as rain gardens or linked bioswales.

Guideline 4.1.3 Minimize hard surface pathways to only those providing access to dwelling units, common outdoor space and on-site service infrastructure.

Guideline 4.1.4 Consider active and/or passive green roofs to reduce the impact of increased building lot coverage on stormwater runoff and urban heat island effect.

See subsection 9.3 for additional Form and Character Guidelines on landscaping

4.2 RAINWATER RETENTION

Guideline 4.2.1 In order to reduce peak stormwater runoff and to conserve water required for landscaping, roof drainage should be designed to:

Figure 13

- (a) provide a minimum 500 liters (132.1 gallons) for every 350 square metres (3,767.4 square feet) roof area for rainwater storage in barrels or cisterns that allow water to be drawn for landscaping purposes; or
- (b) collect and detain rainwater in accordance with LEED® Gold stormwater design provisions.



Figure 11. **Increased permeability**



Figure 12. **On-site infiltration**



Figure 13. **Rainwater collection**

5 Reduction of Greenhouse Gas Emissions



5.1 VEHICLE CHARGING

Guideline 5.1.1 Vehicle charging infrastructure should be provided as follows:

- (a) 20% of all parking spaces should include an electrical outlet, a receptacle or electric vehicle supply equipment where applicable, and should be supplied by a branch circuit rated not less than 40 A at the nominal voltage of 208 V or 240 V as applicable; and
- (b) adequate space in the electrical room or electrical vault to support future electric vehicle charging for the remaining parking spaces.

See subsection 9.5 for additional Form and Character Guidelines on vehicle parking

Part III – Form and Character Guidelines

Development proposals must contribute to the public realm and demonstrate compatibility with the Moodyville neighbourhood in accordance with these guidelines. The intention is to encourage durable and inviting buildings that respond to local topography, frame public greenways, streets and lanes, and promote landscaped, pedestrian-scale frontages. These guidelines refine the City of North Vancouver Subdivision and Development Control Bylaw and Zoning Bylaw regulations.

6 Site Planning

6.1 BUILDING FORMS

These guidelines direct each project to contribute to the neighbourliness, liveability, sustainability and sense of community in Moodyville (Figure 14). To this end, site conditions and context should influence building form and inform the quantity, size and layout of dwelling units. Although a diversity of building forms is possible, many share a similar consideration of orientation—with special conditions applied to some frontages—building scale and grades.

Guideline 6.1.1 Most building forms, notwithstanding Apartment Use buildings, should have a courtyard separating a building fronting the street and a building fronting the lane.
Figures 15+16

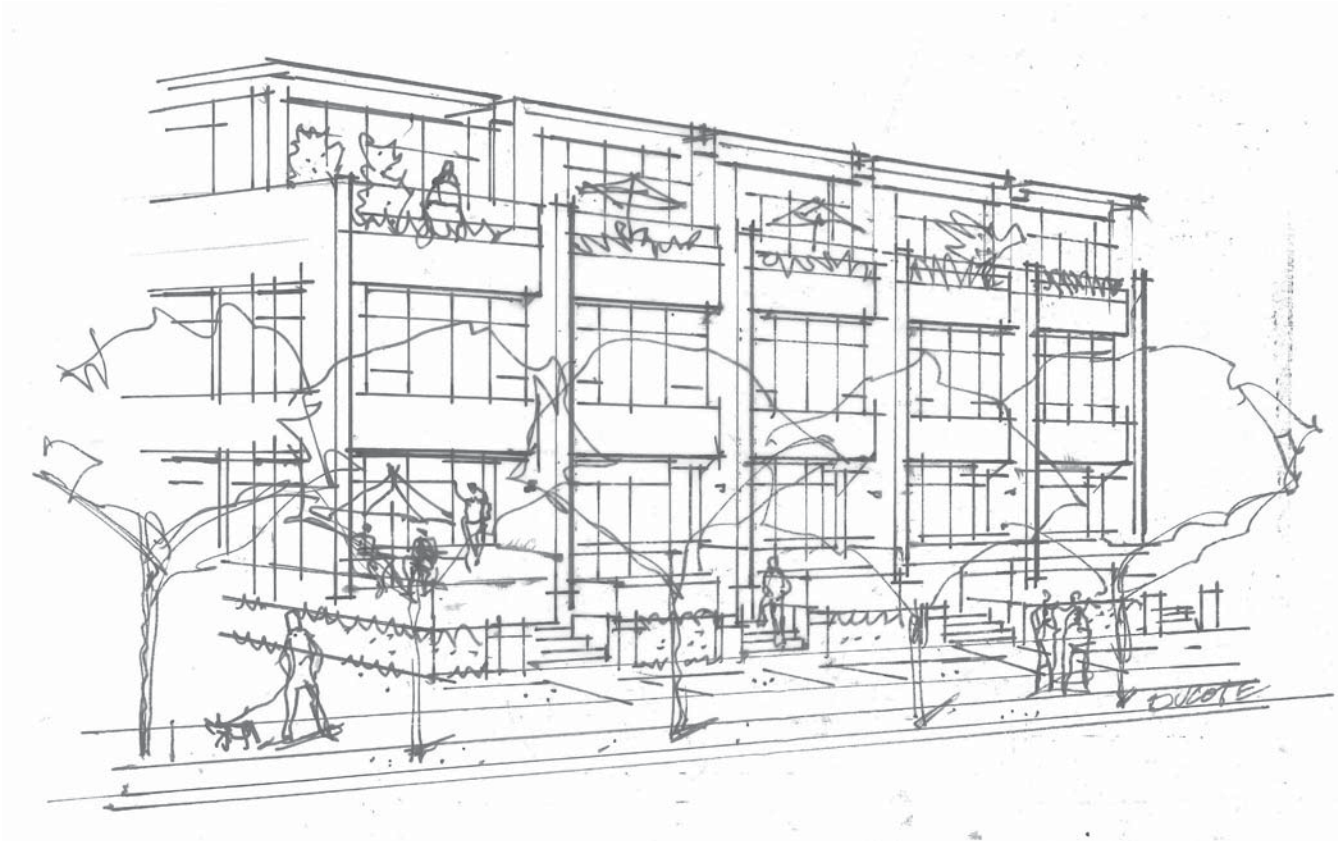
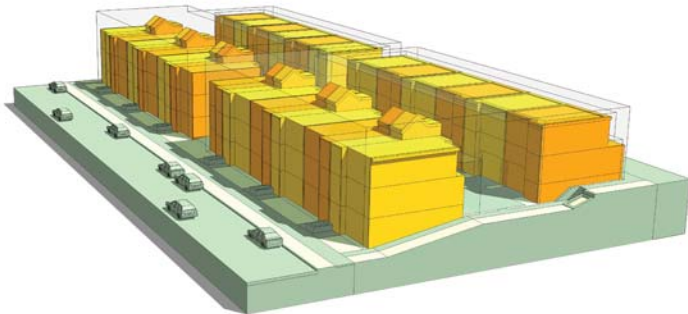
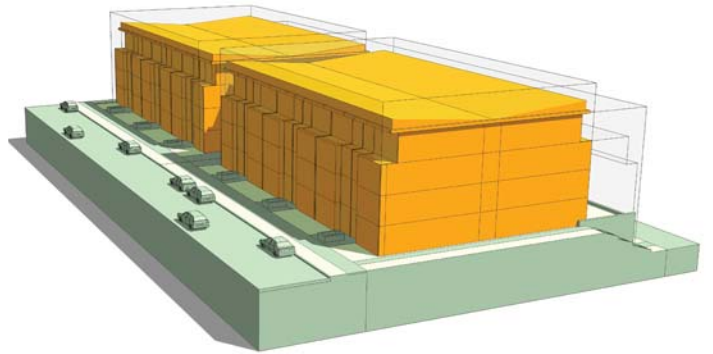

Figure 14.

Ground-oriented building



TOWNHOUSE (EAST 3RD STREET TRANSITION)—1.0 FSR



APARTMENT—1.6 FSR

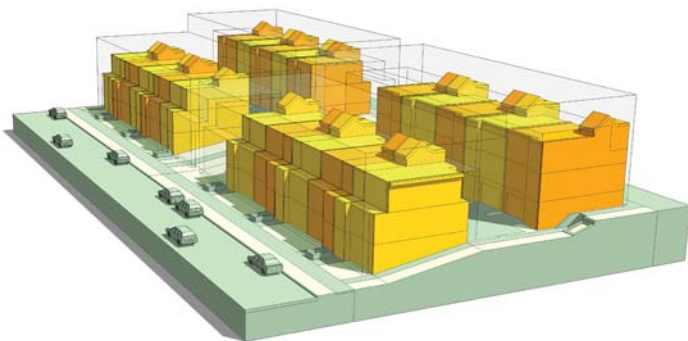

TOWNHOUSE (UPSLOPE)—1.0 FSR

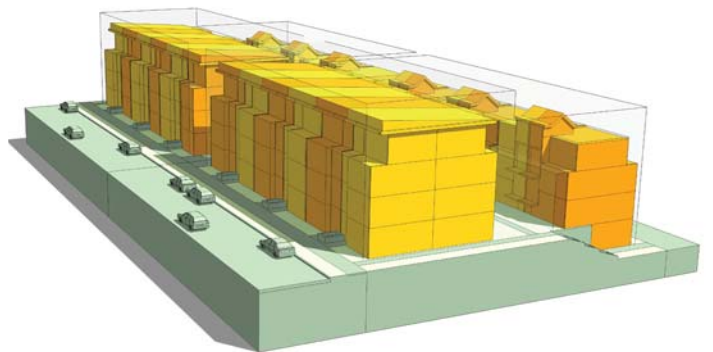

LIVE-WORK STACKED TOWNHOUSE—1.6 FSR

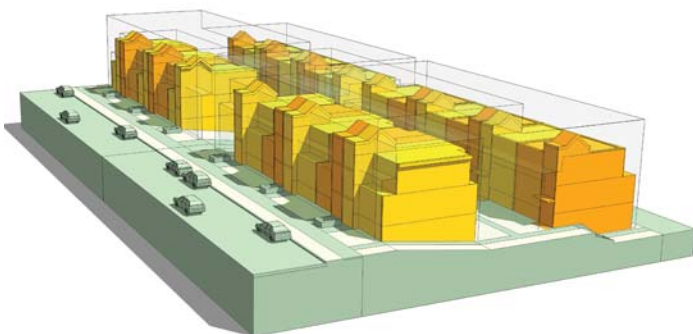

TOWNHOUSE (DOWNSLOPE)—1.0 FSR

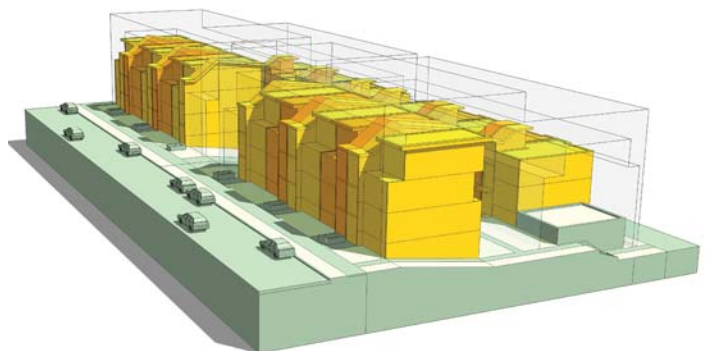

STACKED TOWNHOUSE—1.25 FSR

Figure 15.

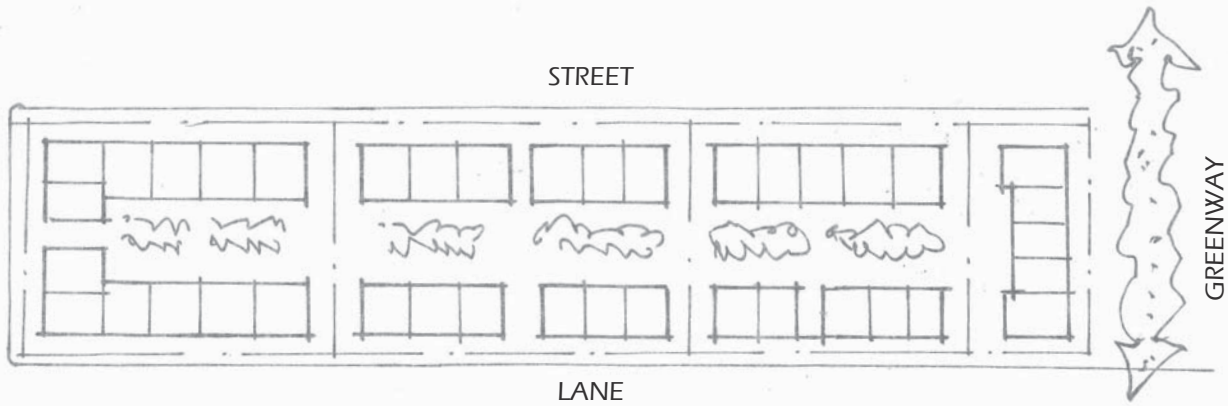

Figure 16.

Building orientation

6.2 ORIENTATION

Guideline 6.2.1 Buildings should support a high-quality pedestrian realm along all frontages—including lanes—with individual unit entries and private and semi-private outdoor spaces.

Guideline 6.2.2 Designs should prioritize frontages, from highest to lowest, in the following order:

Figure 17

- (a) public greenway (Spirit Trail, St. David's Avenue and Queensbury Avenue);
- (b) fronting street;
- (c) flanking street;
- (d) lane;

except that the entrance of a common lobby for an Apartment Use building should be clearly visible from the fronting street.

Guideline 6.2.3 Corner lots should have strong massing at the corner with no blank end walls visible from the public realm. One or more dwelling unit front doors should face each adjoining public greenway or street, where possible.

Figure 18

Guideline 6.2.4 Special attention is required for back-to-back Townhouse arrangements to ensure dwelling units that front solely into the courtyard have strong unit identity and clear access from the street.

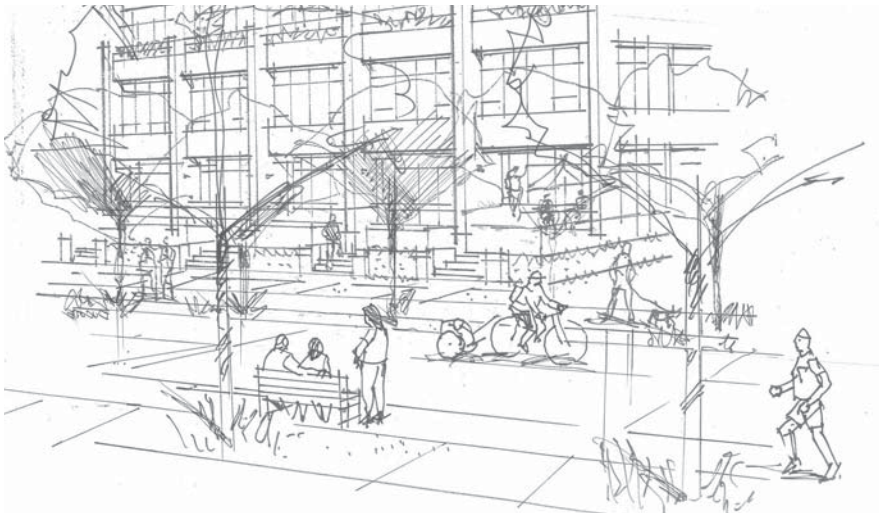

Figure 17. **Public greenway frontage**

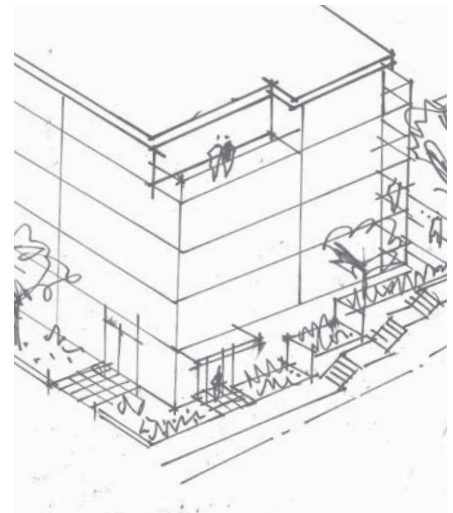

Figure 18. **Corner lot frontage**

6.3 SPECIAL CONDITIONS

Special Conditions apply to lands in accordance with Figure 19



Guideline 6.3.1 Due to their proximity to Mixed Use designated lands, and in order to strengthen a transit corridor, the following frontages are identified for application of live-work provisions in accordance with these guidelines:

- (a) East 3rd Street: RM-2, Medium Density Apartment Residential 2 Zone, between St. Patrick's Avenue and Ridgeway Avenue.

Guideline 6.3.2 Dwelling units should respond to existing and planned public greenways in the same manner as a fronting street, including:

- (a) emphasis on openness and sightlines;
 - (b) minimization of blank end walls;
 - (b) reduction in the height of accessory structures such as fences to 1.2 metres (3.9 feet); and
 - (c) landscaping comprised of ground-oriented vegetation and high-branched trees;
- with similar active frontages facing Moodyville Park.

Guideline 6.3.3 Inclusion of on-site buildings scheduled on the City's Heritage Register and of other heritage character buildings is encouraged. If buildings are incompatible with development on site, the transfer of structures to other sites or commemoration—while not preferred—may be considered.

6.4 COURTYARD

Guideline 6.4.1 The long side of the courtyard should be parallel to the Front Lot line, but may vary where:

Figure 20

- (a) the priority frontage is a flanking public greenway in accordance with Guideline 6.2.2;
- (b) the open end of the courtyard facing the fronting street is partially enclosed through reduced building separation, architectural massing and/or open space design;
- (c) a range of building orientations and/or building types are expressed on the site; or
- (d) the building orientation is a response to specific site conditions or context.

Guideline 6.4.2 Minimum courtyard width should be in accordance with Guideline 7.5.2.

Guideline 6.4.3 Buildings sited along the lane should:

Figure 21

- (a) be visible from the street in accordance with Guideline 7.5.1; and
- (b) have lane-facing front door entries for floors within 1.6 metres (5.2 feet) of finish grade, where possible.

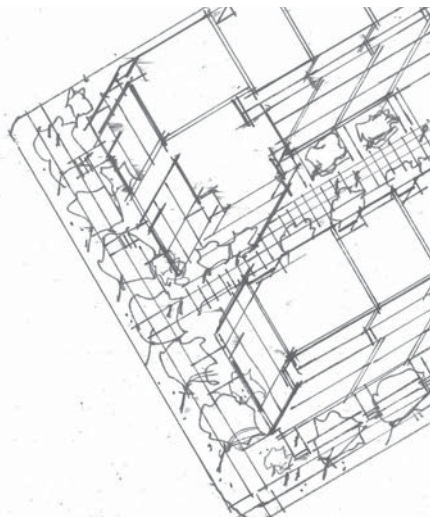

Figure 20. **Narrowed courtyard**



Figure 21. **Buildings visible from street**

6.5 BUILDING SCALE

Guideline 6.5.1 Massing and materiality should:

Figure 22

- (a) reflect a pedestrian scale;
- (b) present buildings as assemblies of ground-oriented dwelling units;
- (c) express an incremental rhythm across the facade with entries spaced no more than 7 metres (23 feet) apart, where possible; and
- (d) communicate varied and incremental development for lots larger than 2,600 square metres (27,986 square feet).

Guideline 6.5.2 Roofs, balconies and projections should:

Figure 23

- (a) be architecturally integrated;
- (b) respond to topography with the roof line stepping down with the slope of the street;
- (c) avoid substantially increasing the apparent scale of the building; and
- (d) avoid substantially increasing overshadowing of the sidewalk or public greenway.

6.6 GRADE

Guideline 6.6.1 Buildings and structures should follow the existing grade in order to minimize retaining wall and exposed parkade faces over:

- (a) 1 metre (3.3 foot) height within 6 metres (19.7 feet) of any property line; and
- (b) 1.5 metre (4.9 foot) height elsewhere on the lot;

with stepped and landscaped structures used to minimize the visual impact when grades require higher structures.



Figure 22.

Streetscape rhythm

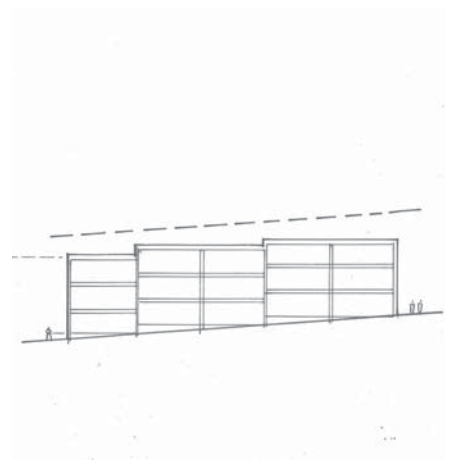

Figure 23.

Roof stepping with slope

Guideline 6.6.2 Stairs within the minimum setback:

Figure 24

- (a) should be perpendicular from the Front Lot Line when the difference between the height of the stairs or landing and the finish grade at the Front Lot Line is less than 1.2 metres (3.9 feet);
- (b) should meet finish grade a minimum distance of 1.8 metres (6 feet) from the Front or Exterior Side Lot Line, and in no instance should the furthest edge of a landing be less than 0.6 metres (2 feet) from a public greenway, street or lane; and
- (c) may be parallel to the Exterior Side Lot Line to take advantage of the predominant slope and to minimize the number of required stairs.

Guideline 6.6.3 Habitable basement or cellar rooms should:

Figure 25

- (a) be not more than 1.8 metres (5.9 feet) beneath the adjacent finish grade; and
- (b) have a ceiling height greater than 2.4 metres (7.9 feet).

Guideline 6.6.4 In support of a live-work character, the difference between the finish floor of the first storey along live-work frontages identified in Guideline 6.3.1 and the finish grade at the Front Lot Line should be not morze than 0.6 metres (2 feet).

Guideline 6.6.5 One-storey Townhouse units accessible from finish grade are encouraged to meet Level 2 of the Adaptable Design Guidelines in accordance with Section 423 of the City's Zoning Bylaw.

Figure 26

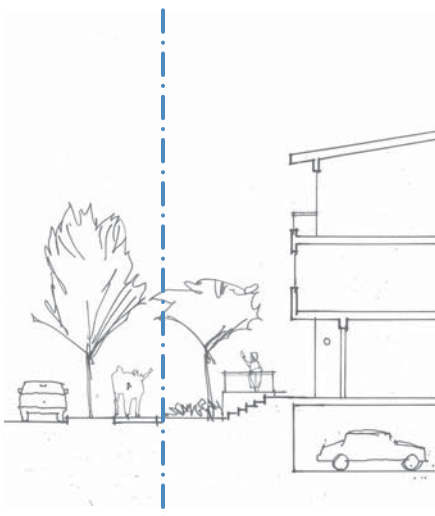

Figure 24. **Entry stairs in setback**

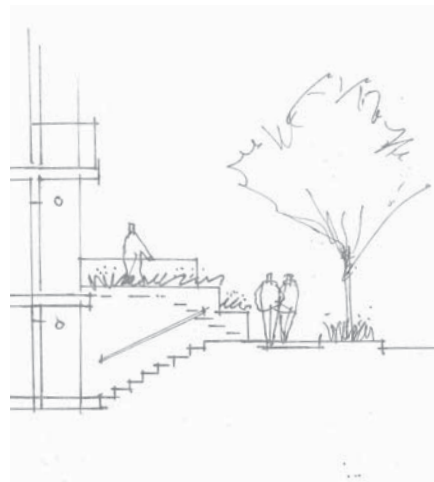

Figure 25. **Habitable basement or cellar**



Figure 26. **Universal accessibility**

7 Building Envelope



Figure 27 is provided to support the building envelope guidelines in this section. Detailed drawings of different building types are included in Part IV of the Moodyville Guidelines.

For the purposes of these guidelines, a Building Face is defined as the sum of exterior walls, including apertures such as windows and doors, within 1.5 metres (4.9 feet) of the minimum setback that in total create a plane parallel to the lot line.

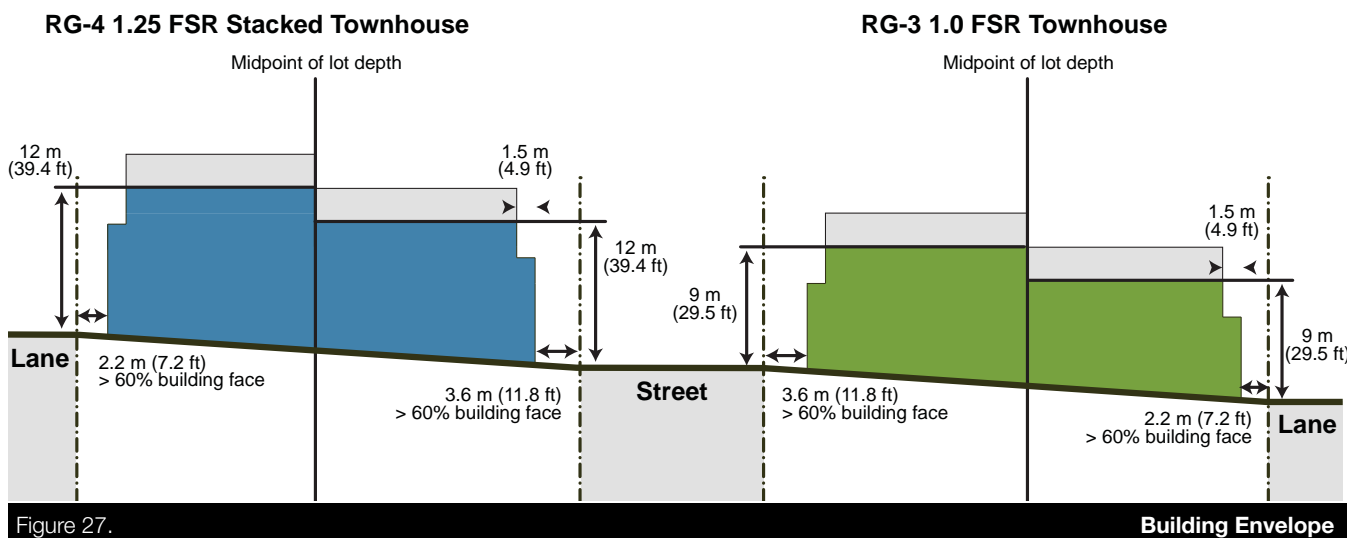

7.1 SETBACK

Guideline 7.1.1 In order to increase articulation of the facade, a minimum of:

Figure 28

(a) 30% of the area of the Building Face of live-work frontages identified in Guideline 6.3.1 along the Front Lot Line; and

(b) 60% of the area of the Building Face along all other lot lines;

should be set back at least 0.6 metres (2 feet) further than the minimum setback from the lot line permitted by the Zoning Bylaw.

Guideline 7.1.2 Notwithstanding Guideline 7.1.1, no additional setback than the minimum permitted by the Zoning Bylaw is expected for setbacks from the following lot lines:

(a) Interior Side Lot Line; and

(b) Rear Lot Line in the RG-3 Ground-Oriented Residential 3 Zone along East 3rd Street in response to the increased minimum setback in the Zoning Bylaw.

Guideline 7.1.3 In order to reduce visual and overshadowing impacts of the building height on the street or lane, any upper storey should be set back from the Building Face a minimum of:

(a) 2.2 metres (7.2 feet) for any upper storey fronting the lane and within 3.4 metres (11.2 feet) of the maximum allowed height in the RG-3 Ground-Oriented Residential 3 Zone north of East 3rd Street, in response to lower density residential use on the opposing side of the lane; and

(b) 1.5 metres (4.9 feet) for any upper storey within 5.5 metres (18 feet) of the maximum allowed height in the zone for all other buildings.

Guideline 7.1.4 Notwithstanding Guideline 7.1.3, one projection of no more than 3 metres (9.8 feet) width per dwelling unit is allowed for stairway access to the upper storey as required by grades.

Figure 29

Guideline 7.1.5 Notwithstanding Guideline 7.1.3, no additional upper storey setback is expected for buildings fronting East 3rd Street in the RG-3 Ground-Oriented Residential 3 Zone in response to the streetwall height on the opposing side of the street.



Figure 28.

Minimum building face and upper storey setbacks

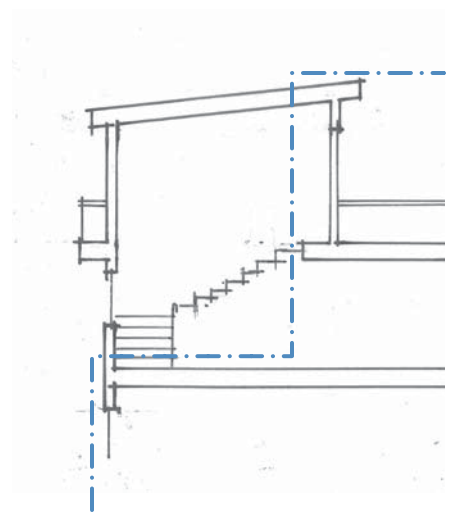

Figure 29.

Upper storey access

- Guideline 7.1.6** In order to present no more than four storeys height on a street frontage, a building should:
- Figure 30**
- (a) follow the grade along the flanking street, where possible;
 - (b) where a four-storey, Apartment Use building is over a basement, the upper storey facing the Exterior Side Lot Line should be set back a minimum of 1.5 metres (4.9 feet) from the building face below; and
 - (c) where a four-storey, Townhouse Use building is over a basement, the visual impact of the upper storey should be reduced through increased setback and/or materiality.

- Guideline 7.1.7** Notwithstanding Guideline 7.1.6, a building on a lot with a Front Lot Line common to the north side of East 3rd Street between St. Patrick's Avenue and St. David's Avenue may present as more than four storeys height on its downslope frontage as a transitional response to the Lonsdale Regional Town Centre.

- Guideline 7.1.8** In order to provide an appropriate transitional response to existing buildings, buildings should be set back an additional 1.2 metres (3.9 feet) from the shared Interior Lot Line for any portion of the building within 7.6 metres (24.9 feet) of the Front Lot Line as exists prior to the adoption of Zoning Bylaw, 1995, No. 6700, Amendment Bylaw, 2016, No. 8464 when:
- Figure 31**
- (a) the front face of the building on the adjacent lot is greater than 5.5 metres (18.0 feet) and less than 9.5 metres (31.2 feet) from the Front Lot Line and less than 2.4 metres (7.9 feet) from the shared Interior Side Lot Line; or
 - (b) the building on the adjacent lot is scheduled on the City's 2013 Heritage Register;
- except when the lot has a frontage of less than 16 metres (52.5 feet) and/or a Front Lot Line common to East 3rd Street.

- Guideline 7.1.9** Windows of habitable rooms should be set back a minimum of 1.5 metres (4.9 feet) from a parking space parallel to the lane with special attention to the lane interface.
- Figure 32**

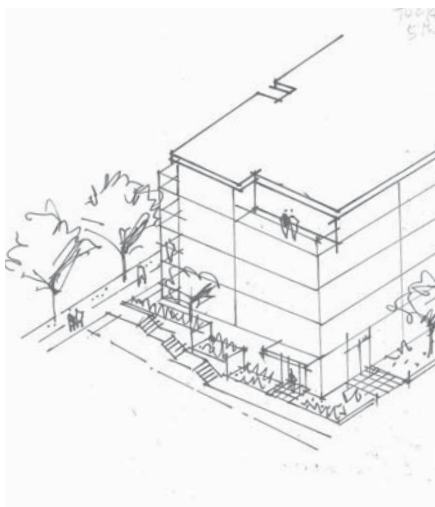

Figure 30. **Four-storey over basement**

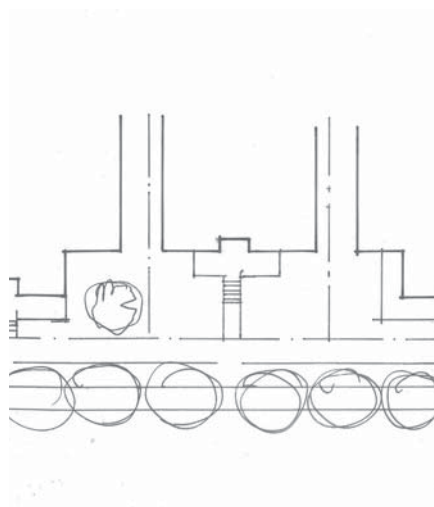

Figure 31. **Transitional setback**

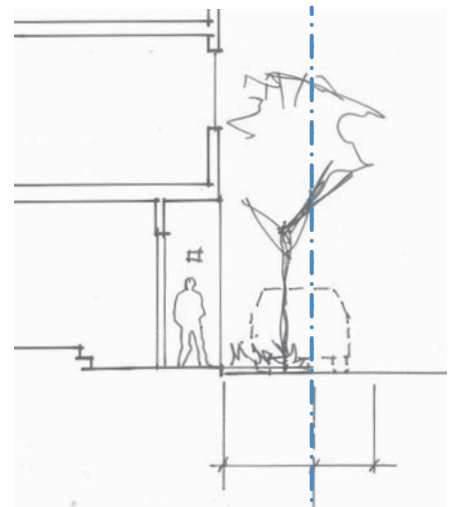

Figure 32. **Lane parking setback**

7.2 LENGTH

- Guideline 7.2.1** In order to achieve a desirable streetscape and to communicate a pedestrian scale, the maximum building length (i.e. distance parallel to the fronting street) should be:
- (a) 92 metres (301.8 feet) for Apartment Use;
 - (b) 46 metres (150.9 feet) for Rowhouse Use considered the sum of the frontage of all buildings on adjoining lots without a building separation of at least 3 metres (9.8 feet); and
 - (c) 46 metres (150.9 feet) for all other Uses including Townhouse Use.

- Guideline 7.2.2** Any increase in the building length specified in Guideline 7.2.1 should:
- (a) be in response to specific site conditions or context;
 - (b) result in a proportional increase in building separation along the frontage and/or increase in building setback from a side lot line on either side of the building;
 - (c) be visually mitigated with variation in the setback from the Front Lot Line, materiality and/or facade elements; and
 - (d) be limited when the building length is along a public greenway.

- Guideline 7.2.3** Any building over 61 metres (200.1 feet) length should have a courtyard that meets the following minimum standards:

Figure 33

- (a) 7.3 metre (24.0 foot) length of the building frontage that includes the midpoint of the building frontage;
- (b) 3.7 metre (12.1 foot) depth from the Building Face;
- (c) building program variation to emphasize this separation through the location of lobby, common amenity areas and/or active design elements; and
- (d) design variation to emphasize this separation through changes in setback from the Front Lot Line, materiality and facade elements.

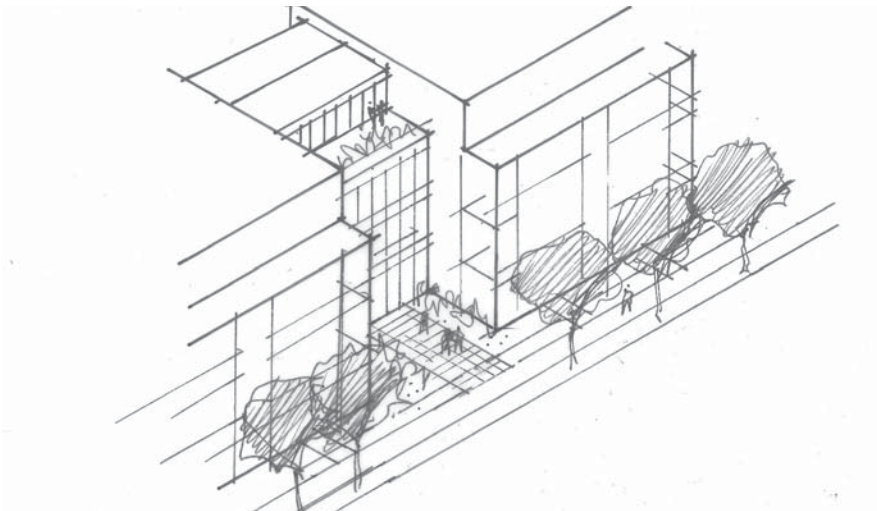

Figure 33.

Mid-frontage courtyard

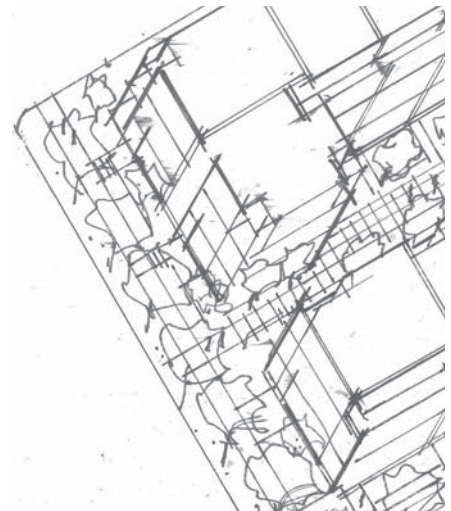

Figure 34.

Maximum building depth

Guideline 7.2.4 Notwithstanding Guideline 7.2.3, any upper storey within 5.5 metres (18 feet) of the maximum allowed height in the zone and aligned with the midpoint courtyard frontage should be set back a minimum:

- (a) 1 metre (3.3 feet) from the Building Face along the midpoint courtyard; and
- (b) 1 metre (3.3 feet) from the rear Building Face.

7.3 DEPTH

Guideline 7.3.1 In order to minimize overshadowing, limit view impacts and promote privacy between adjoining properties, the building depth (i.e. distance perpendicular to the fronting sheet) should be no greater than:

Figure 34

- (a) 25 metres (82 feet) for Apartment Use; and
- (b) 15 metres (49.2 feet) for all other Uses.

Guideline 7.3.2 Any building depth greater than that specified in Guideline 7.3.1 should be a response to specific site conditions or context, and/or should result from a mix of residential use types, with the Building Face demonstrating:

- (a) varied materiality and/or facade elements;
- (b) front door entrances if along a public greenway or street; and
- (c) where the building depth is over 18 metres (59.1 feet), a change in setback from the Interior Side Lot Line.

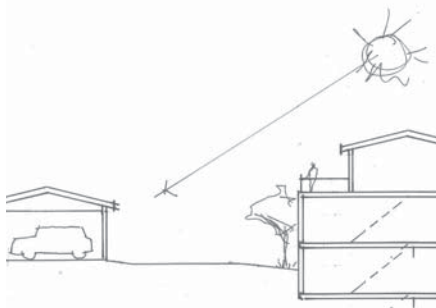

Figure 35. **Reduced building envelope**

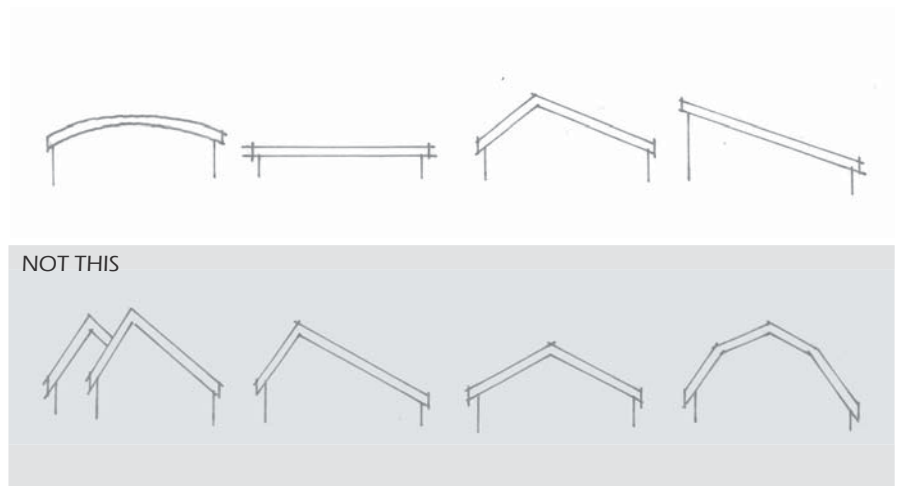

Figure 36.

Roof forms

7.4 HEIGHT

Guideline 7.4.1 The top 3 metres (9.8 feet) of the building envelope is limited to roof structures and the following elements architecturally integrated into the building form:

- (a) height exceptions in accordance with the Zoning Bylaw;
- (b) rooftop hatches and rooftop terrace railings no higher than required by the British Columbia Building Code and set back a minimum 1 metre (3.3 feet) from the parapet in order to reduce overlook concerns; and
- (c) exterior stairs and landings providing access to the rooftop located in accordance with minimum required setbacks.

Guideline 7.4.2 Due to the lowered permitted building envelope in the Zoning Bylaw for the RG-3 Ground-Oriented Residential 3 Zone north of East 3rd Street, for buildings between the Mid Lot Line and the lane:

Figure 35

- (a) Guideline 7.4.1 does not apply; and
- (b) rooftop hatches and terraces within 3.4 metres (11.2 feet) of the maximum allowed height are not permitted.

Guideline 7.4.3 Overshadowing and view impacts should be minimized by roof designs that demonstrate:

Figure 36

- (a) that the maximum permitted height is limited to localized points if reached at all;
- (b) simple forms with no greater than 4:12 pitch;
- (c) overhangs limited to those required for solar and rain protection; and
- (d) a sensitive response to public greenways.

Guideline 7.4.4 The maximum floor-to-floor height is 3.2 metres (10.5 feet). This height may be exceeded to the maximum permitted in the Zoning Bylaw for:

Figure 37

- (a) common lobby and amenity space for Apartment Use; and
- (b) no greater than 5% of Gross Floor Area for all residential uses.

Guideline 7.4.5 Notwithstanding Guideline 7.4.4, the first floor of live-work frontages identified in Guideline 6.3.1 should have a minimum floor-to-floor height of 3.4 metres (11.2 feet) and a maximum floor-to-floor height of 4 metres (13.1 feet).

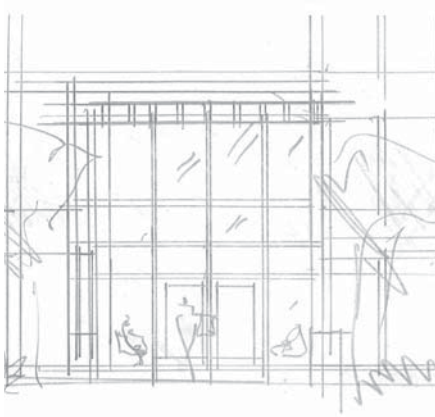

Figure 37. Increased lobby height

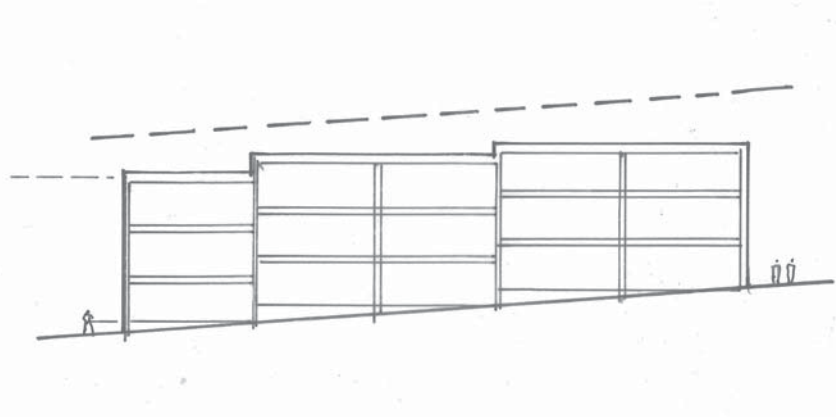

Figure 38. Cross-slope adjustment

Guideline 7.4.6 In order to allow buildings to respond to cross-slope grades, or those running parallel to the Front Lot Line, notwithstanding Guideline 7.4.1, the upper storey may project into the top 3 metres (9.8 feet) of the building envelope with:

Figure 38

- (a) the projection should be minimized; and
- (b) a similar proportion of the upper storey should be lower than the maximum unrestricted height as above the maximum unrestricted height;

Guideline 7.4.7 In order to allow buildings to respond to steep slopes running perpendicular to the Front Lot Line, notwithstanding Guideline 7.4.1, the upper storey may project into the top 3 metres (9.8 feet) of the building envelope impacted by the slope where the average building grade along the Mid Lot Line is at least:

- (a) 5 metres (16.4 feet) higher than the Front Lot Line, the upper storey may project into the envelope closest to the Front Lot Line; and
- (b) 5 metres (16.4 feet) higher than the Rear Lot Line, the upper storey may project into the envelope closest to the Rear Lot Line.

Guideline 7.4.8 In order to be minimize overshadowing, limit view impacts and promote privacy between adjoining properties, stair enclosures and/or elevators with rooftop landings should be architecturally integrated into the building form and should be:

Figure 39

- (a) limited to common access for Apartment Use when within the top 3 metres of the building envelope in accordance with Guideline 7.4.1 and set back a minimum of 3 metres (9.8 feet) from the parapet; and
- (b) considered a storey for all other Uses.

7.5 SEPARATION

Guideline 7.5.1 The minimum building separation between building ends on a lot (i.e. distance separating buildings as viewed from the fronting street) should be not less than:

Figure 40

- (a) 6 metres (19.7 feet) where buildings are located between the Front Lot Line and the Mid Lot Line; and
- (b) 3 metres (9.8 feet) where buildings are located elsewhere on the lot.

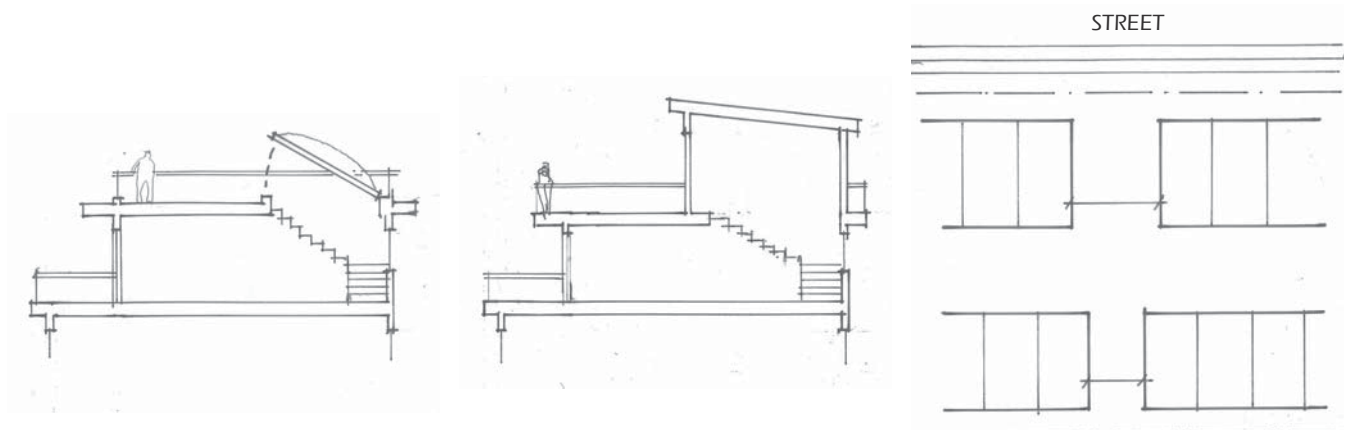

Figure 39.

Rooftop access

Figure 40. **Reduced separation at lane**

Guideline 7.5.2 The minimum building separation between Building Faces on a lot (i.e. distance separating buildings across courtyards) should be not less than:

- (a) 9.8 metres (32.2 feet) above the 2nd storey; and
- (b) 7.4 metres (24.3 feet) for the 1st and 2nd storey where the reduced building separation is in the form of a projection of the southerly building in order to not reduce solar access within the courtyard;

with the base of the 1st storey considered the landscaped roof of an enclosed parkade or the surface of the exterior courtyard driveway.

Guideline 7.5.3 Notwithstanding Guideline 7.5.2, one projection of no more than 3 metres (9.8 feet) width per dwelling unit is allowed for stairway access to the upper storey as required by grades.

Guideline 7.5.4 The minimum building separation may be reduced:

Figure 41

- (a) to respond to specific site conditions or context with a proportional increase in building separation for the remainder of the impacted Building Faces;
- (b) between building ends by providing more frequent building separations and/or more generous setbacks from side lot lines, the sum of which meets or exceeds the sum of the minimum distances otherwise required; and
- (c) on corner lots to partially enclose the courtyard and to provide a more continuous building frontage along the flanking street;

with specific attention to minimize overshadowing, limit view impacts and promote privacy between adjoining properties, and at no time should the minimum building separation be less than 3 metres (9.8 feet).

Guideline 7.5.5 Allowed projections, designed to minimize overshadowing and view impacts, may extend into minimum building separation no greater than:

Figure 42

- (a) 1 metre (3.3 feet) for eaves and other architectural features;
- (b) 1.2 metres (3.9 feet) for balconies on the northerly side of courtyards to partially cover an exterior courtyard driveway in order to not reduce solar access within the courtyard; and
- (c) 0.3 metres (1 foot) for all other balconies.

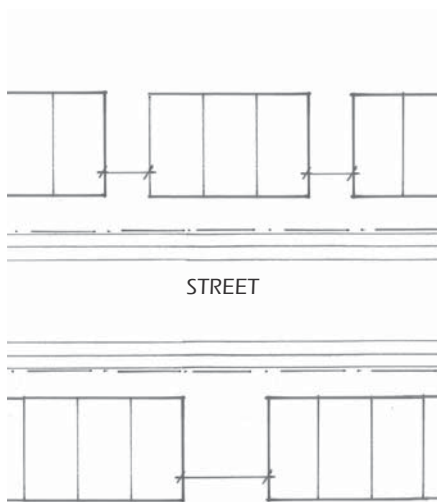

Figure 41. **Redistributed spacing**

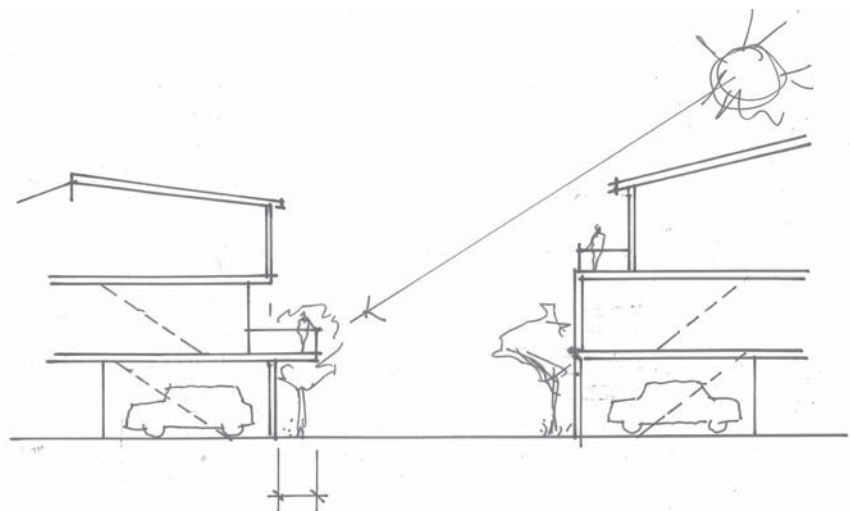

Figure 42. **Courtyard solar access**

8 Building Design



8.1 DESIGN VARIATION

Guideline 8.1.1 The architectural design of buildings should:

- (a) create visual interest through variations in height, depth and massing;
- (b) demonstrate individuality while contributing to a harmonious streetscape;
- (c) present contemporary facades that are free of visual clutter;
- (d) use material or colours to create purposeful accents; and
- (e) avoid ornate and traditional design elements such as trim associated with single-family housing.

Guideline 8.1.2 Townhouse units should demonstrate subtle design variations to strengthen unit identity and support a pedestrian scale on the street.

Guideline 8.1.3 In accordance with Guideline 5.2.3, development of properties listed on the Heritage Register should:

- (a) respect the architectural integrity of the registered building;
- (b) design new construction to be complementary, but distinct; and
- (c) be encouraged to legally protect the registered building, in concert with the development permit application and with the benefit of the Amenity Share exemption in Section 418 of the Zoning Bylaw.

8.2 MATERIALITY

Guideline 8.2.1 In accordance with Guideline 6.2.1, facades fronting greenways or lanes should be of similarly high quality as those fronting streets.

Guideline 8.2.2 Materials should:

Figure 43

- (a) be substantial and durable while expressing warmth and interest, including non-pressure treated wood, metal, rough stone, rock dash stucco and architectural concrete;
- (b) reinforce form by emphasizing entrances and be purposeful in the expression of the relative visual weight between lower and upper storeys;
- (c) create visual interest through a varied palette and purposeful application that communicates depth along the facade, emphasizes unit identity and/or articulates building separations;
- (d) avoid imitative or faux applications to represent building elements; and
- (e) anticipate and incorporate the impacts of weather, with exterior use of wood applied in weather protected areas such as soffits and entries.

Guideline 8.2.3 In accordance with Guideline 6.6.1, exposed concrete and foundations should be minimized.

Figure 44

Guideline 8.2.4 Material transitions should occur at an inside corner rather than on the same plane.

Figure 45

Guideline 8.2.5 The first floor of live-work frontages identified in Guideline 6.3.1 should be distinguished by materials or finish, including a higher proportion of windows than the overall facade.

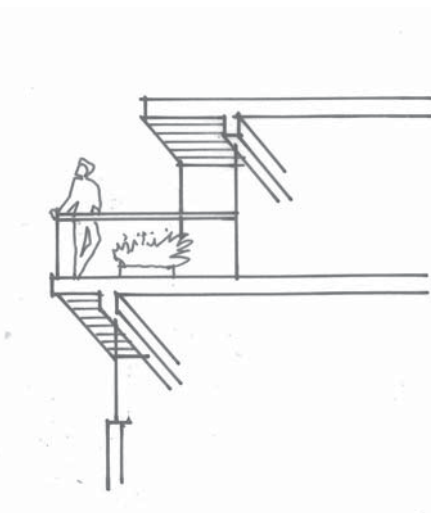

Figure 43. Incorporate weathering

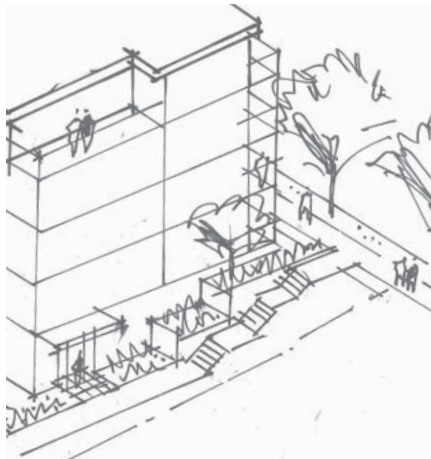

Figure 44. Minimize exposed concrete

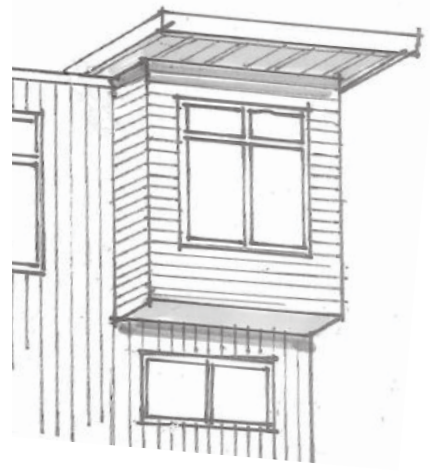

Figure 45. Material transition

8.3 ENTRANCES

Guideline 8.3.1 In accordance with Guideline 6.1.2, Townhouse dwelling units and ground floor Apartment Use dwelling units, where possible, should each have an individual exterior entrance that:

Figure 46

- (a) is visible from—and with a pedestrian path to—a public greenway, street or lane;
- (b) may be accessed directly from the courtyard for upper storey dwelling units;
- (c) may be defined through grade separation, but entrances more than 1 metre (3.3 feet) lower than the adjoining finished grade are discouraged; and
- (d) is universally accessible from the sidewalk, where possible.

Guideline 8.3.2 The semi-public use of common building lobbies for Apartment Use should be highlighted by:

- (a) varied depth from the adjoining building facade facing the street;
- (b) signage, weather protection and lighting;
- (c) a minimum ceiling height of 3.3 metres (10.8 feet); and
- (d) convenient universal access from the sidewalk integrated into the landscape design.

Guideline 8.3.3 Apartment Use buildings should, where possible, have:

Figure 47

- (a) natural light and ventilation in corridors;
- (b) corridor length limited by placement of vertical circulation; and
- (c) stairs and access designed in accordance to the City's Active Design Guidelines.

Guideline 8.3.4 Lock-off units may have entrances on an elevation not oriented toward the street or lane if clear wayfinding is provided.

Figure 48

Guideline 8.3.5 Ground-floor units that comprise live-work frontages identified in Guideline 6.3.1 should have:

- (a) direct access from the fronting street;
- (b) signage that is architecturally integrated, reflective of the residential character of the neighbourhood and in accordance with the City's Sign Bylaw.

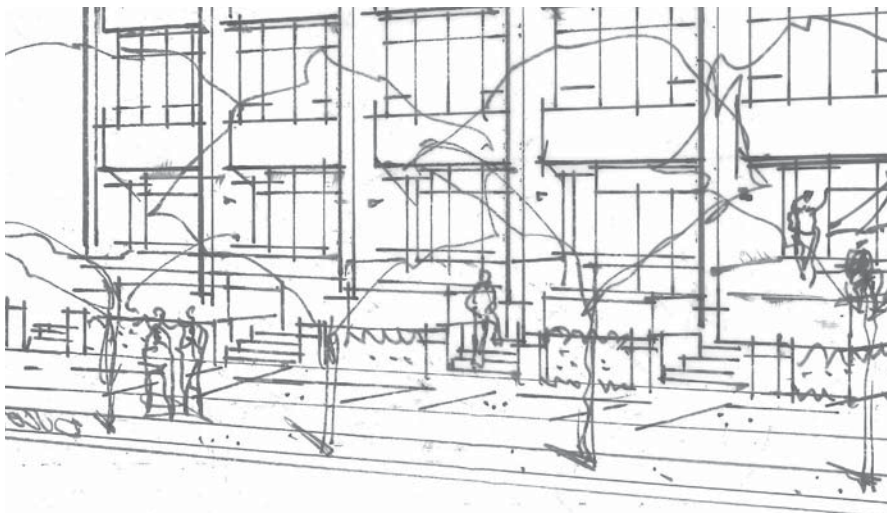

Figure 46.

Individual unit entrances

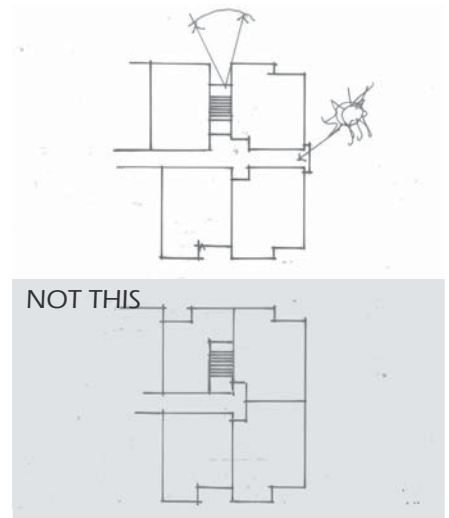

Figure 47.

Apartment active design

8.4 WINDOWS

Guideline 8.4.1 Windows, skylights and overhangs should respond to solar orientation with the southern Building Face designed with high window-wall ratios and appropriate overhangs to control seasonal solar gain.
Figure 49

Guideline 8.4.2 In order to support access to light and ventilation, building layouts are encouraged to have:

- (a) where Apartment Use, more than four corner units per floor;
- (b) where Townhouse Use, dwelling units with windows on a minimum of two exterior walls with different exposures, or a maximum unit depth of 11 metres (36.1 feet);
- (d) vertical orientation of windows; and
- (e) operable windows designed to facilitate air flow to habitable rooms.

Guideline 8.4.2 may be waived if in conflict with design requirements to meet the Passive House standard.

Guideline 8.4.3 In order to support privacy:

- (a) direct alignment of windows within 6 metres (19.7 feet) of different dwelling units should be avoided;
- (b) exterior stairs accessing upper level dwelling units should be located close to entry doors; and
- (c) private and semi-private outdoor spaces should be located outside of ground-level windows under the same tenure, where possible.

Guideline 8.4.4 Common amenity areas should overlook an adjoining public greenway, street or lane.



Figure 48. **Lock-off unit entrance**

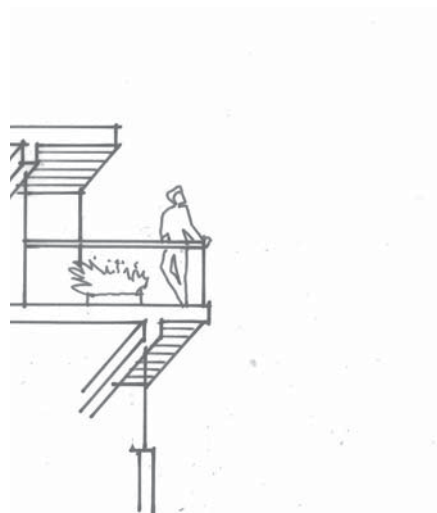

Figure 49. **Seasonal solar gain**

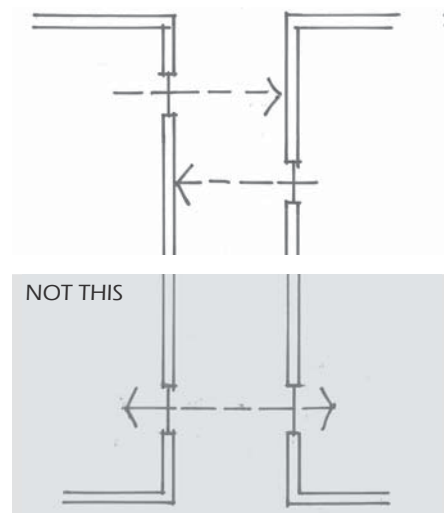

Figure 50. **Window alignment**

8.5 BALCONIES

Guideline 8.5.1 Entry porches, balconies, patios and stairs and stair landings should be partially recessed into the building massing, where possible. Guideline 8.5.1 may be waived if in conflict with design requirements to meet the Passive House standard.
Figure 51

Guideline 8.5.2 The minimum average outdoor space per dwelling unit, inclusive of roof terraces and patios, should be not less than:
(a) 10 square metres (107.6 square feet) for Townhouse use; and
(b) 5 square metres (53.8 square feet) for all other uses;
with one or more private outdoor spaces with a dimension of at least 1.8 metres (5.9 feet) accessible to each dwelling unit.

Guideline 8.5.3 The total area of all balconies and porches, exclusive of rooftop terraces, should not exceed 10% of the gross floor area.

Guideline 8.5.4 Guardrail materiality should maximize light for dwelling units with the exception of balconies:
(a) less than 3 metres (9.8 feet) above finish grade; and
(b) on live-work frontages identified in Guideline 6.3.1;
which should be designed to increase privacy.

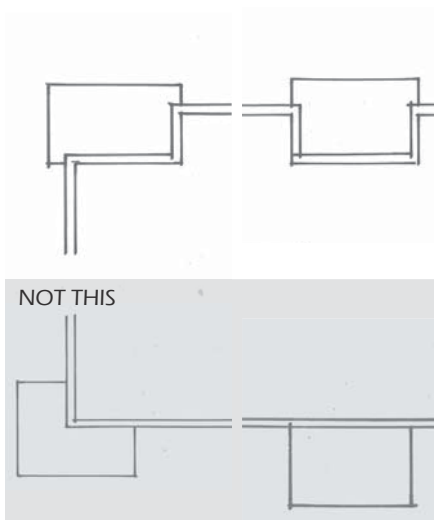

Figure 51.

Recessed balcony



Figure 52.

Rooftop terrace

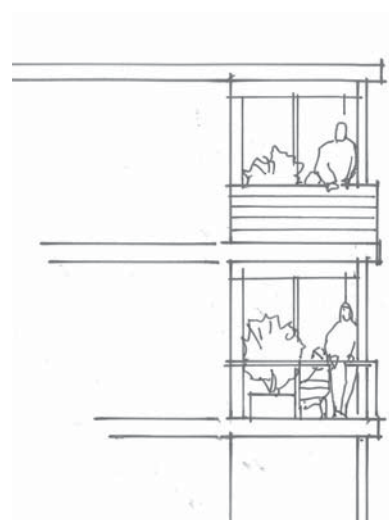

Figure 53.

Guardrail transparency

9 Open Space and Access



9.1 INTERFACE

Guideline 9.1.1 A 1.8 metre (5.9 foot) landscaped area should adjoin the street with limited hardscape, such as paths, stairways, retaining walls, decks and porches.
Figure 54

Guideline 9.1.2 Notwithstanding Guideline 9.1.1, live-work frontages identified in Guideline 6.3.1 should provide landscape and hardscape adjacent to the street that:

- (a) reflects the more commercial character of these blocks;
- (b) allows a clear path from ground floor entries to the sidewalk; and
- (c) incorporates purposeful planting areas.

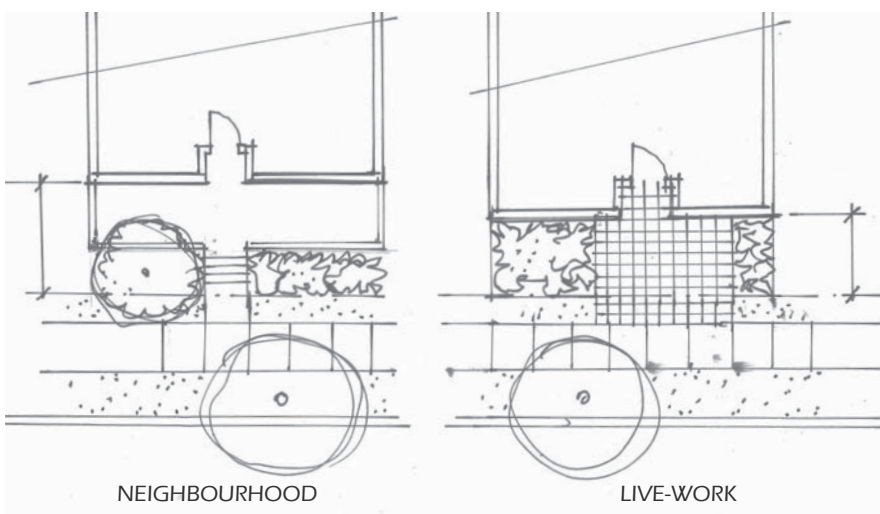

Figure 54.

Neighbourhood and live-work landscaping



Figure 55.

Street interface

Guideline 9.1.3 The remaining Front and Exterior Side Lot setback outside the landscaped area in Guideline 9.1.1 may include:
Figure 55

- (a) ground-level decks and porches no greater than 1 metre (3.3 feet) above or beneath the public sidewalk, where possible; and
 - (b) stairways accessing dwelling entrances;
- with specific attention to limiting the length of the frontage interrupted by structures.

Guideline 9.1.4 A 1.6 metre (5.2 foot) landscaped area should adjoin the lane with structures including decks, porches and retaining walls up to 1 metre (3.3 foot) height set back a minimum of 0.3 metres (1 foot) from the Rear Lot Line.
Figure 56

Guideline 9.1.5 Fences within required Front, Rear or Exterior Side Lot setback should be:
Figure 57

- (a) visually open;
- (b) no greater than 1.2 metre (3.9 foot) height, where possible; and
- (c) when upslope from the street or lane defining the setback, the maximum fence height should be measured from the lowest finish grade within 0.5 metres (1.6 feet), where possible.

Guideline 9.1.6 Notwithstanding Guideline 9.1.5, fences located elsewhere on the lot should be:

- (a) integrated with landscaping through use of trellises and planted screens, where possible;
- (b) designed to reduce the impact of surface parking, driveways and exterior courtyard driveways on neighbouring lots;
- (c) no greater than 1.8 metre (6 foot) height.

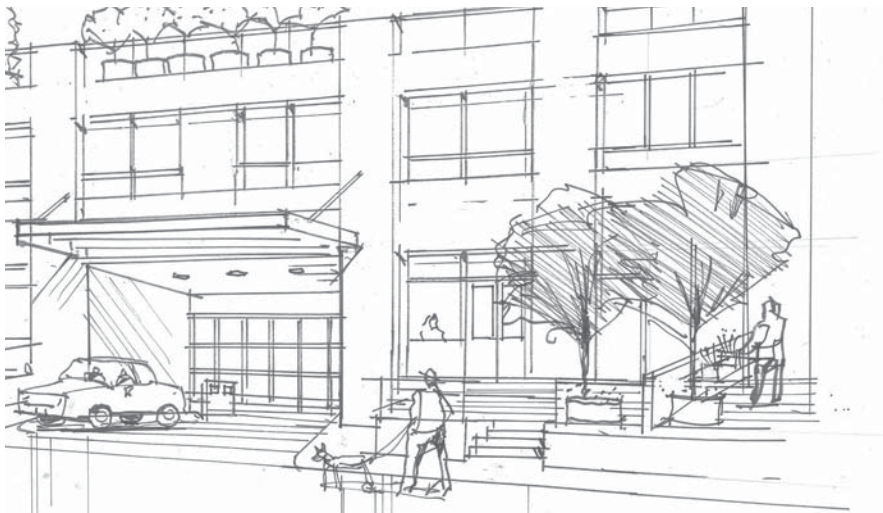

Figure 56.

Lane interface



Figure 57.

Fence height

9.2 OPEN SPACE

Guideline 9.2.1 Apartment Use buildings on lots larger than 2,600 square metres (27,986 square feet) should include common outdoor space with:

- (a) active street and lane frontages;
- (b) shared children's play space; and
- (c) shared gardening areas with ancillary storage and utilities;

designed in accordance with the City's Active Design Guidelines.

Guideline 9.2.2 Apartment Use buildings and other uses on lots larger than 2,600 square metres (27,986 square feet) should consider:

Figure 58

- (a) bench seating and visitor bicycle racks near the building or courtyard entrances that exceed Zoning Bylaw minimum requirements; and
- (b) opportunities for on-site public art.

Guideline 9.2.3 Provision of public mid-block pedestrian connections is encouraged.

Figure 59

9.3 LANDSCAPING

Guideline 9.3.1 Prominent existing trees and landscape features should be removed only due to the following conditions:

- (a) conflict with utilities and services;
- (b) inability to be reasonably accommodated within the building envelope; or
- (c) confirmation of disease provided by a certified arborist;

and, if trees must be removed, designs should include landscaping that will replace the urban forest over time.

Guideline 9.3.2 All on-site trees and landscape features to be retained should be guarded with industry standard tree-protection fencing through land clearing, demolition and construction phases.

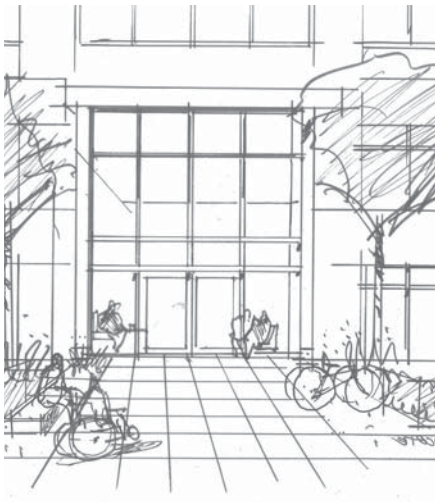

Figure 58. **Apartment Use entrance**



Figure 59. **Mid-block connection**

Guideline 9.3.3 Planting for on-site landscaping should be selected for qualities beyond aesthetic, including:

- (a) low water demand and drought tolerance;
- (b) edible fruit and food producing;
- (c) low maintenance, perennial and durable groundcover and low shrubbery;
- (d) native and regionally adaptive;
- (e) a diversity of coniferous and deciduous trees and other plantings; and
- (f) distinct and placemaking characteristics.

Guideline 9.3.4 With the exception of high-branched trees, plant material should reach a maximum height of:

- (a) 0.8 metres (2.6 feet) within a 1.5 metre (5 foot) setback; and
- (b) 1.2 metres (3.9 feet) within a 3.5 metre (11.5 foot); setback;

from a Front, Rear or Exterior Side Lot Line.

Guideline 9.3.5 On-site trees planted 1 metre (3.3 feet) from the Front Lot Line are encouraged with the installation of a rigid root barrier:

Figure 60

- (a) 2 metres (6 feet) long and centred on the tree; and
- (b) 0.5 metres (1.6 feet) deep.

Guideline 9.3.6 Landscaping should soften the appearance of retaining walls and exposed parkades, including:

Figure 61

- (a) planters integrated into guardrails or other structures on the top of walls allowing plants to overhang;
- (b) active green walls; and
- (c) stepped planters with shrubbery or climbing vines growing from the base;

with installation of an appropriate irrigation system.

See subsection 4.1 for additional Conservation Guidelines on permeability

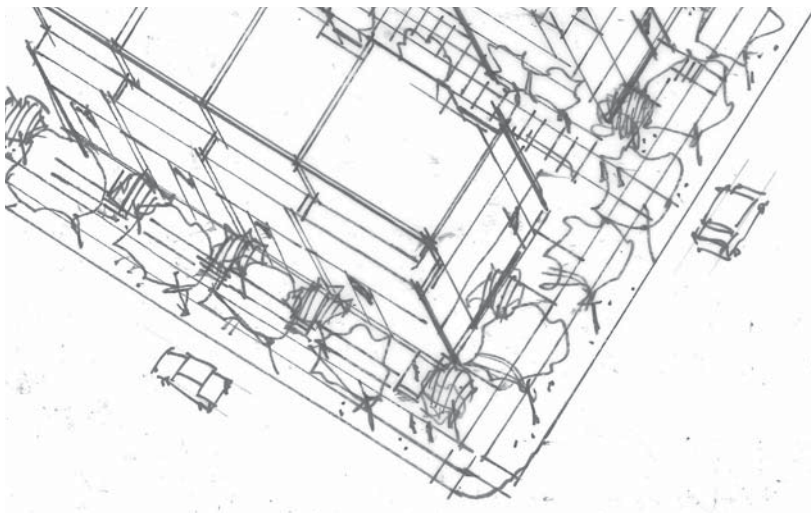

Figure 60. Encouraged tree plantings



Figure 61. Exposed parkade planting

9.4 SAFETY

Guideline 9.4.1 Building and site design should enhance passive surveillance in accordance with Crime Prevention Through Environmental Design (CPTED) principles including:

- (a) Entrances, windows and landscaping designed to encourage visibility and overlook of sidewalks, greenways and other public spaces; and
- (b) Ground-oriented lighting for access pathways and building entrances.

Guideline 9.4.2 In order to facilitate emergency response the following should be provided:

- (a) minimum building separation of 2.4 metres (8 feet) including any structures or projections;
- (b) a clear path of at least 2.0 metres (6.6 feet) width;
- (c) ground-oriented lighting; and
- (d) any additional requirements that may apply to lots without lane access.

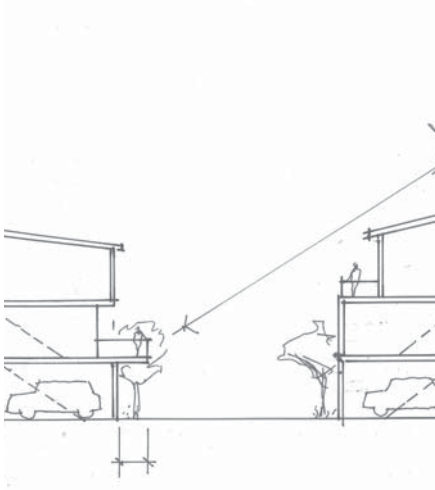

Figure 62. **Exterior courtyard driveway**



Figure 63. **Surface parking setback**



Figure 64. **Parkade entrances**

9.5 VEHICLE PARKING

In accordance with the City's Subdivision and Development Control Bylaw, vehicle access from a street will only be considered where the existing lane is intended for future greenway use or as determined by the City Engineer. With the exception of parking spaces parallel to the lane and car-share parking, the City's Zoning Bylaw only allows parking spaces accessed directly from the lane for developments less than 16 metres (52.5 feet) wide and with a density less than 1.0 FSR.

Guideline 9.5.1 Vehicle parking should be provided in an enclosed parkade structure with landscaping above, except for developments with a density less than or equal to:
Figure 62
(a) 0.75 FSR; or
(b) 1.00 FSR and an average building grade along the Rear Lot Line of at least 1.8 metres (5.9 feet) higher than the average building grade along the Front Lot Line;
which may provide parking access by means of an exterior courtyard driveway.

Guideline 9.5.2 Surface parking spaces and maneuvering aisle should be set back from an Exterior Side Lot Line a minimum of 1 metre (3.3 feet) with specific attention to the landscaped transition.
Figure 63

Guideline 9.5.3 Street and lane frontages should be characterized by residential use with parking located behind in accordance with Guideline 6.1.1. Where possible, the maximum uninterrupted distance of a parkade with an exposed height greater than 1 metre (3.3 feet) above finished grade should be:
(a) 9 metres (29.5 feet) along a lane; and
(b) 7 metres (23 feet) along a flanking street.

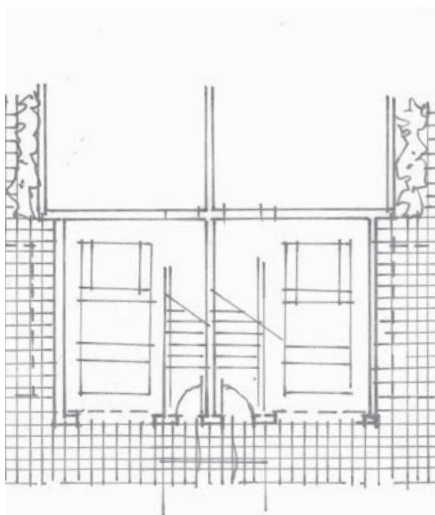

Figure 65. Individual garages on lane



Figure 66.

Screened structures

Guideline 9.5.4 In order to minimize disruption to lane-oriented residential use, parking entrances should:

Figure 64

- (a) integrate vehicle access into the overall site and building design;
- (b) narrow driveway to no greater than 7 metres (23 feet);
- (c) orient access ramps to be perpendicular to the lane, where possible;
- (d) maximize distance from street intersections and in no instance should this distance be less than 4.6 metres (15 feet); and
- (e) locate ramps straddling the Interior Lot Line with registered easements to allow shared access, where possible.

Guideline 9.5.5 Individual garages accessed from the lane should:

Figure 65

- (a) have a maximum width of 3.3 metres (10.8 feet);
- (b) incorporate stair landings or other residential use into the Building Face, and minimize the garage door presence; and
- (c) in total comprise no more than 70% of the Rear Lot Line.

Guideline 9.5.6 A maximum provision of 1.5 parking spaces per dwelling unit, including visitor parking, is encouraged.

Guideline 9.5.7 All parking spaces that utilize a public lane as a maneuvering aisle should have signage posted to indicate the use of the parking space.

See subsection 5.1 for additional Conservation Guidelines on vehicle charging

9.6 SERVICE INFRASTRUCTURE

The location and sizing of mail receptacles, utility infrastructure—including electricity and telecommunications—and solid waste collection must be in accordance with City bylaws. Garbage and recycling collection should be through common facilities in multi-family developments or as determined by the City Engineer.

Guideline 9.6.1 Accessory structures should be screened and integrated with the building and landscape design, including:

Figure 66

- (a) mechanical, utility, mail and communications infrastructure;
- (b) garbage, recycling and composting;
- (c) bicycle parking; and
- (d) rainwater retention, greenhouses and gardening sheds.

Guideline 9.6.2 Access to garbage, recycling and other building services should be principally designed to facilitate pedestrian rather than vehicle-oriented use.

Part IV - Appendix

The drawings in this appendix support the understanding of these guidelines. They are intended for illustrative purposes only. Part III takes precedent in the instance of any inconsistency or inaccuracy with the following materials.

10 Drawings

10.1 OVERVIEW

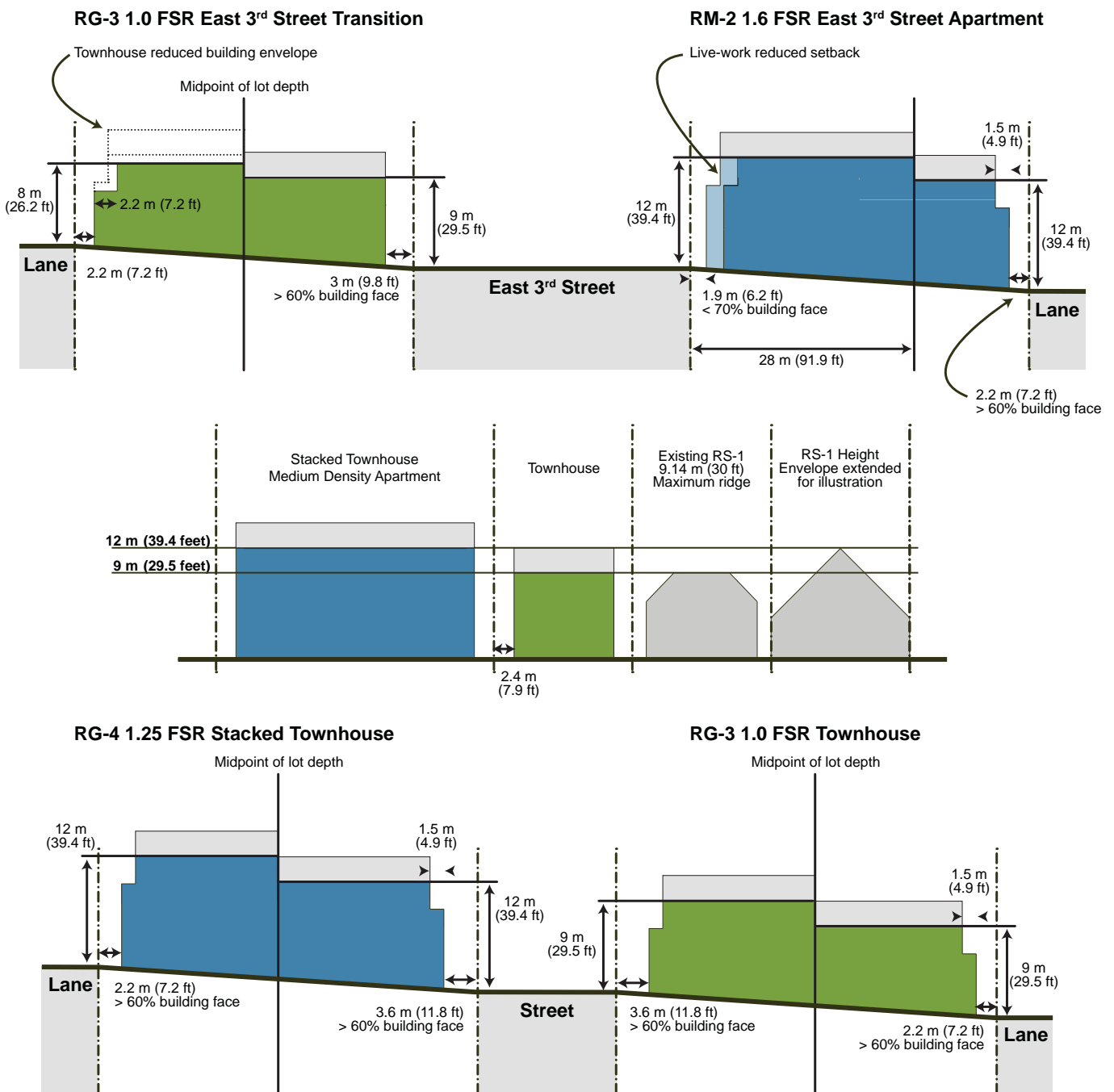

10.2 RG-3 1.0 FSR TOWNHOUSE UPSLOPE OF STREET

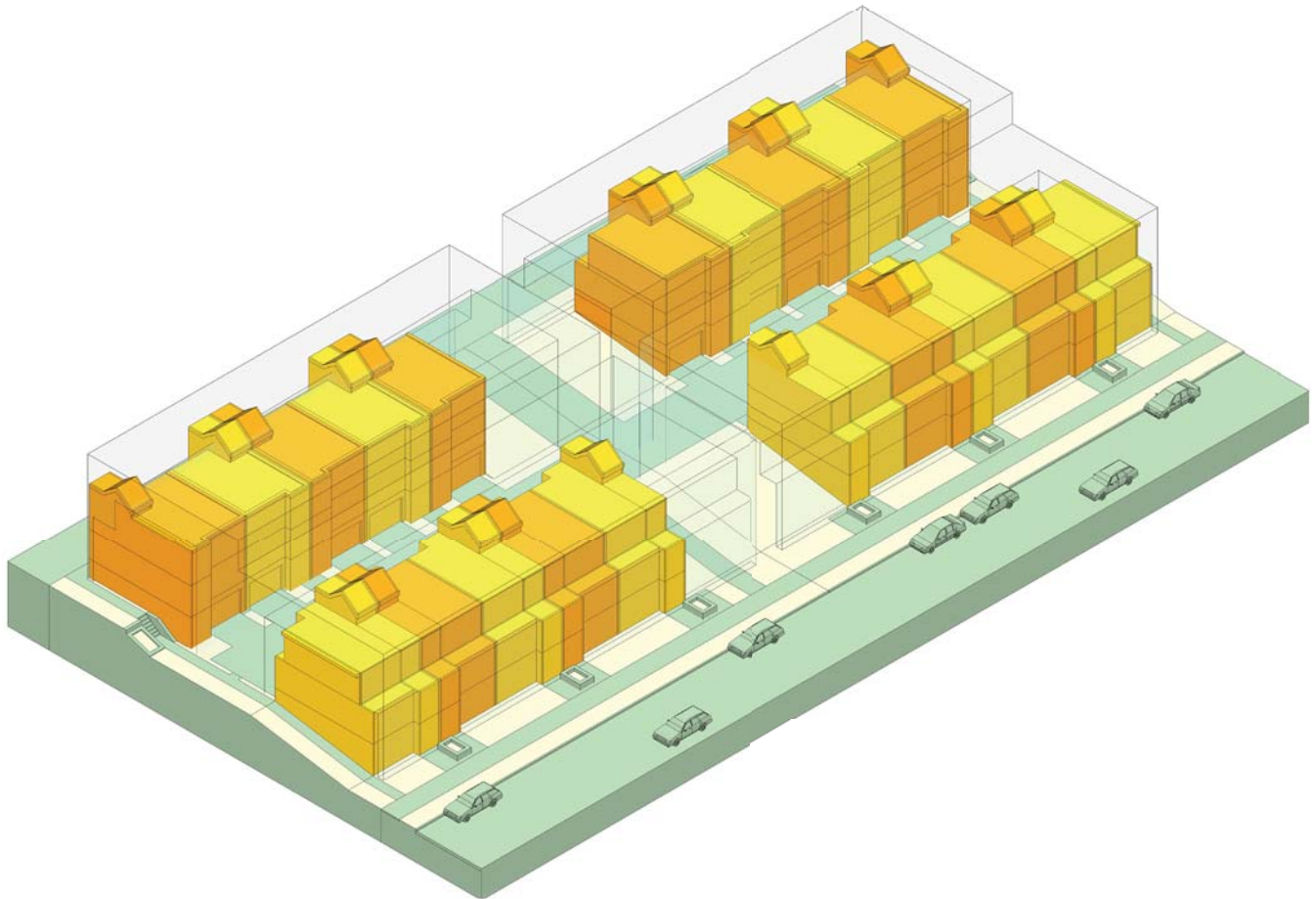
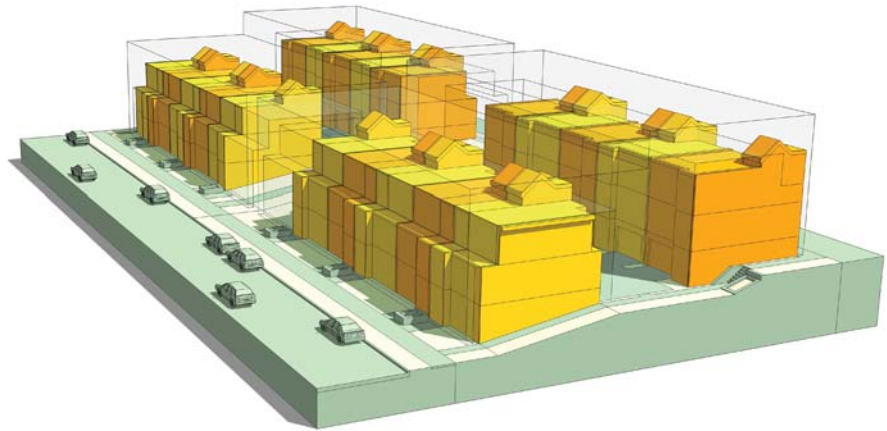

10.3 RG-3 1.0 FSR TOWNHOUSE DOWNSLOPE OF STREET

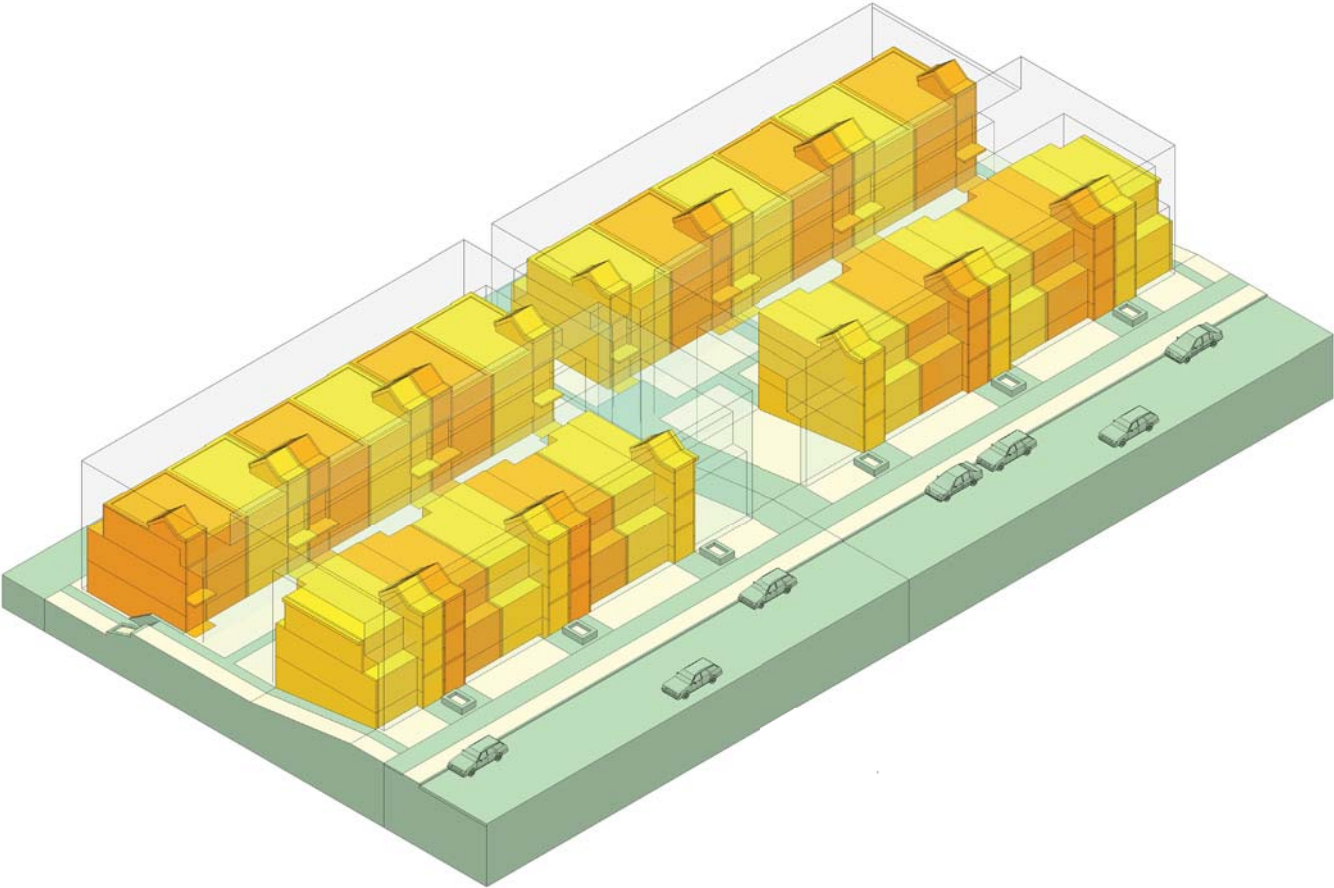
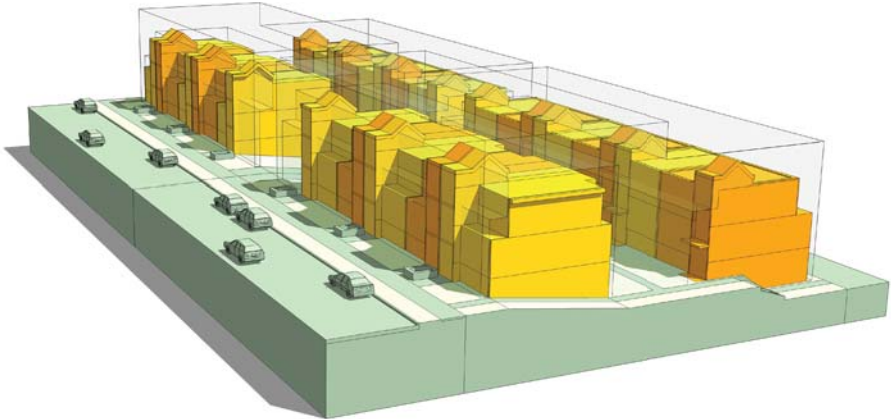

10.4 RG-3 1.0 FSR TOWNHOUSE FRONTING EAST 3RD STREET BETWEEN RIDGEWAY AVENUE AND QUEENSBURY AVENUE

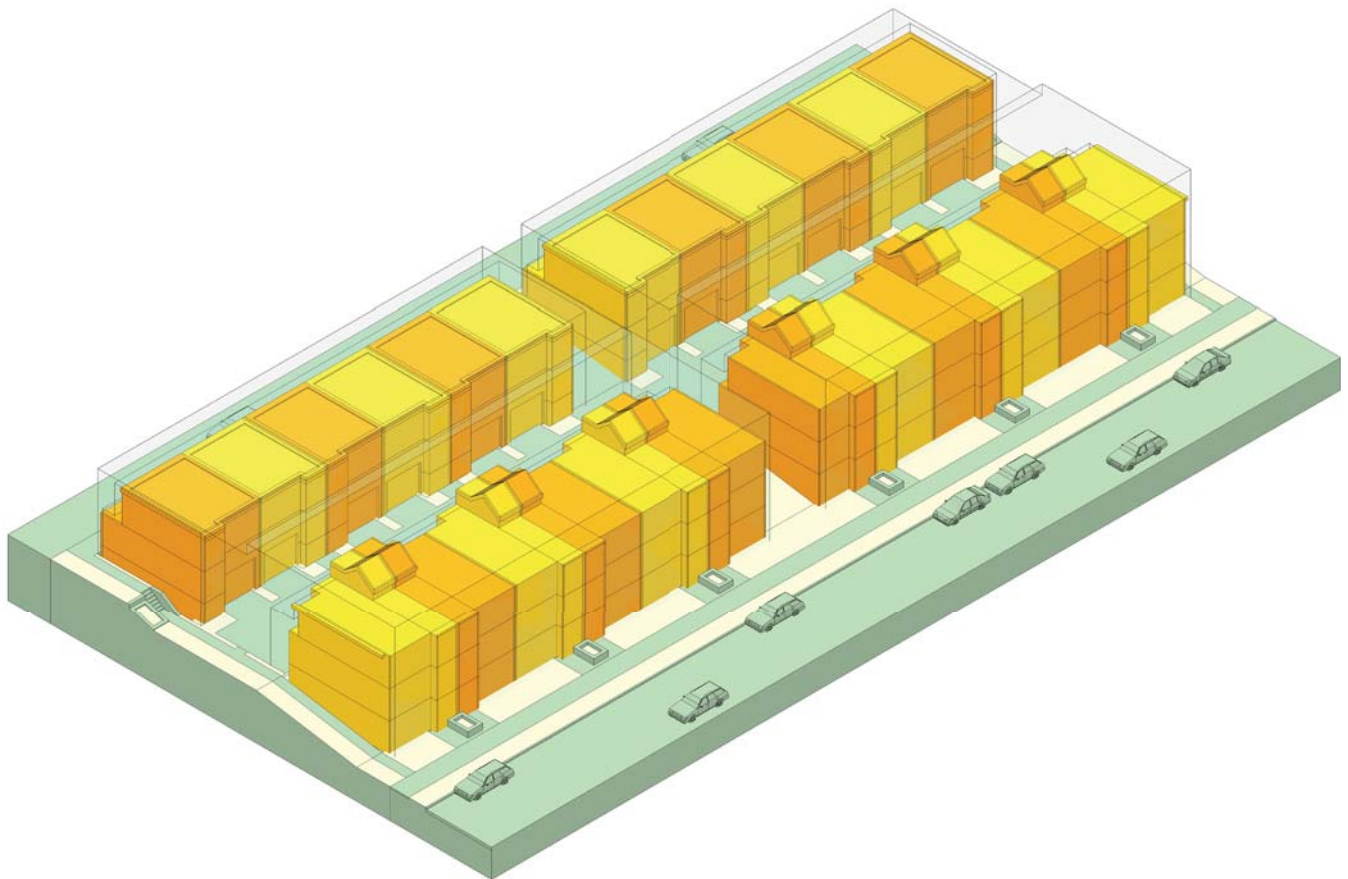
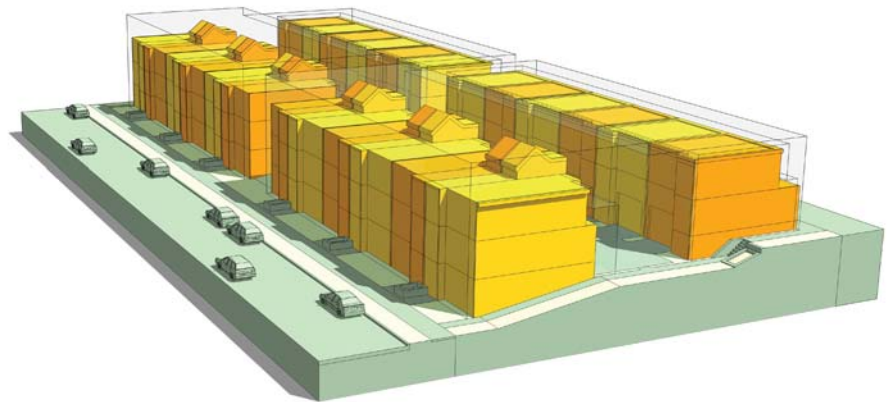

10.5 RG-4 1.25 FSR STACKED TOWNHOUSE

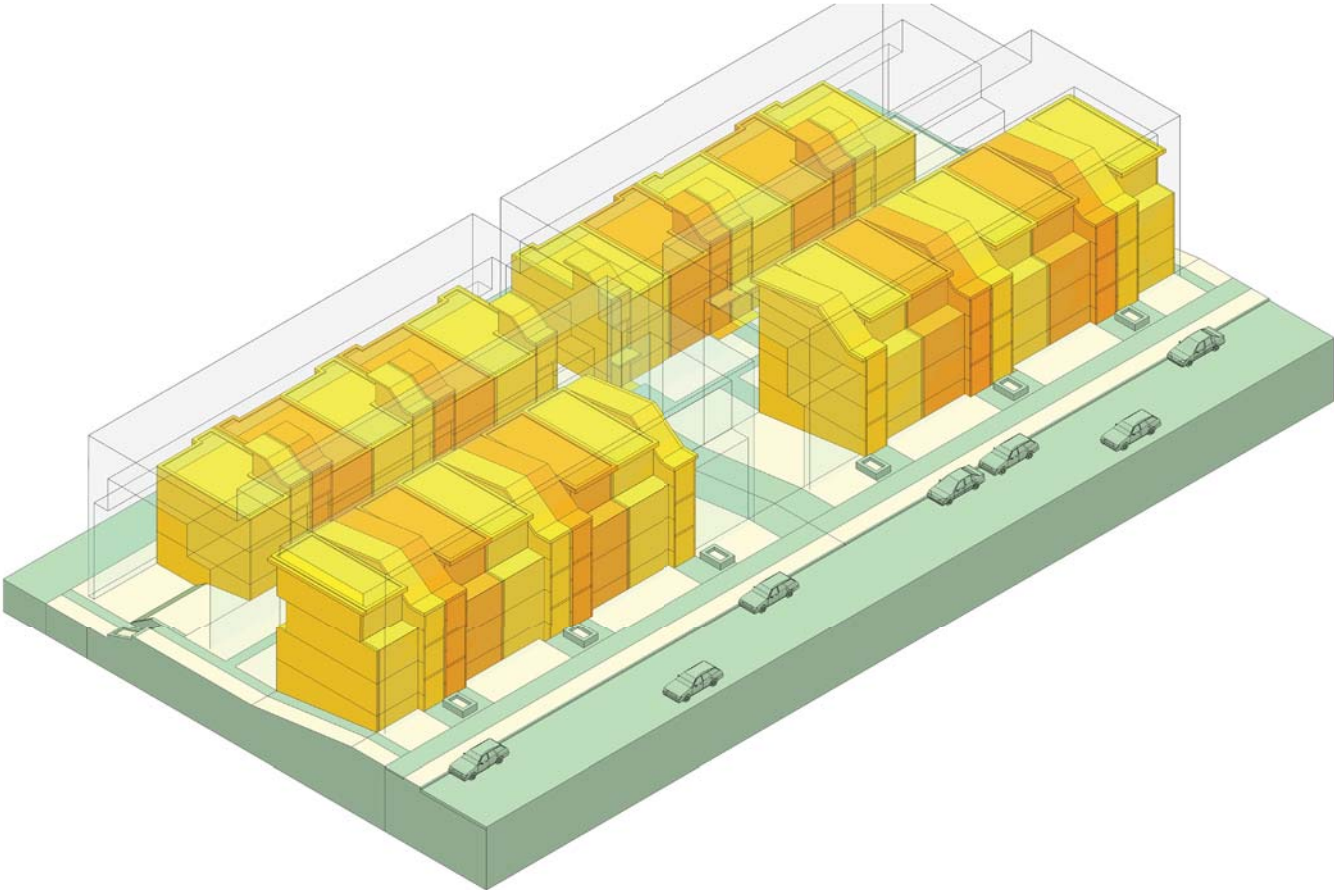
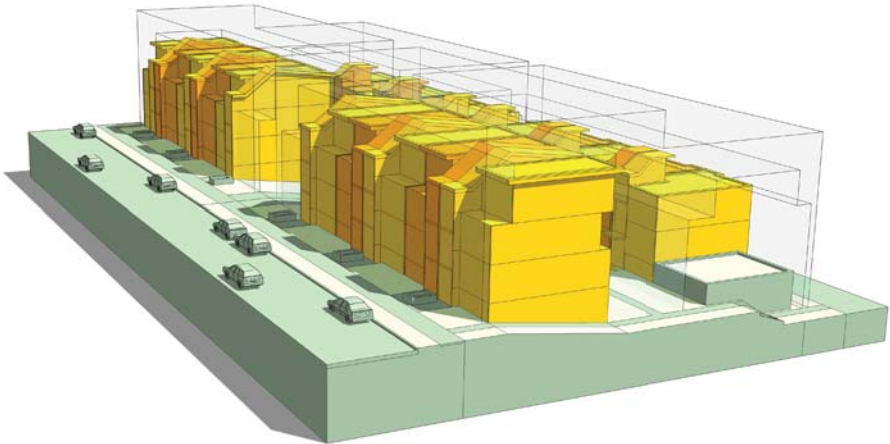

10.6 RM-2 1.6 FSR BACK-TO-BACK STACKED TOWNHOUSE WITH LIVE-WORK FRONTAGE

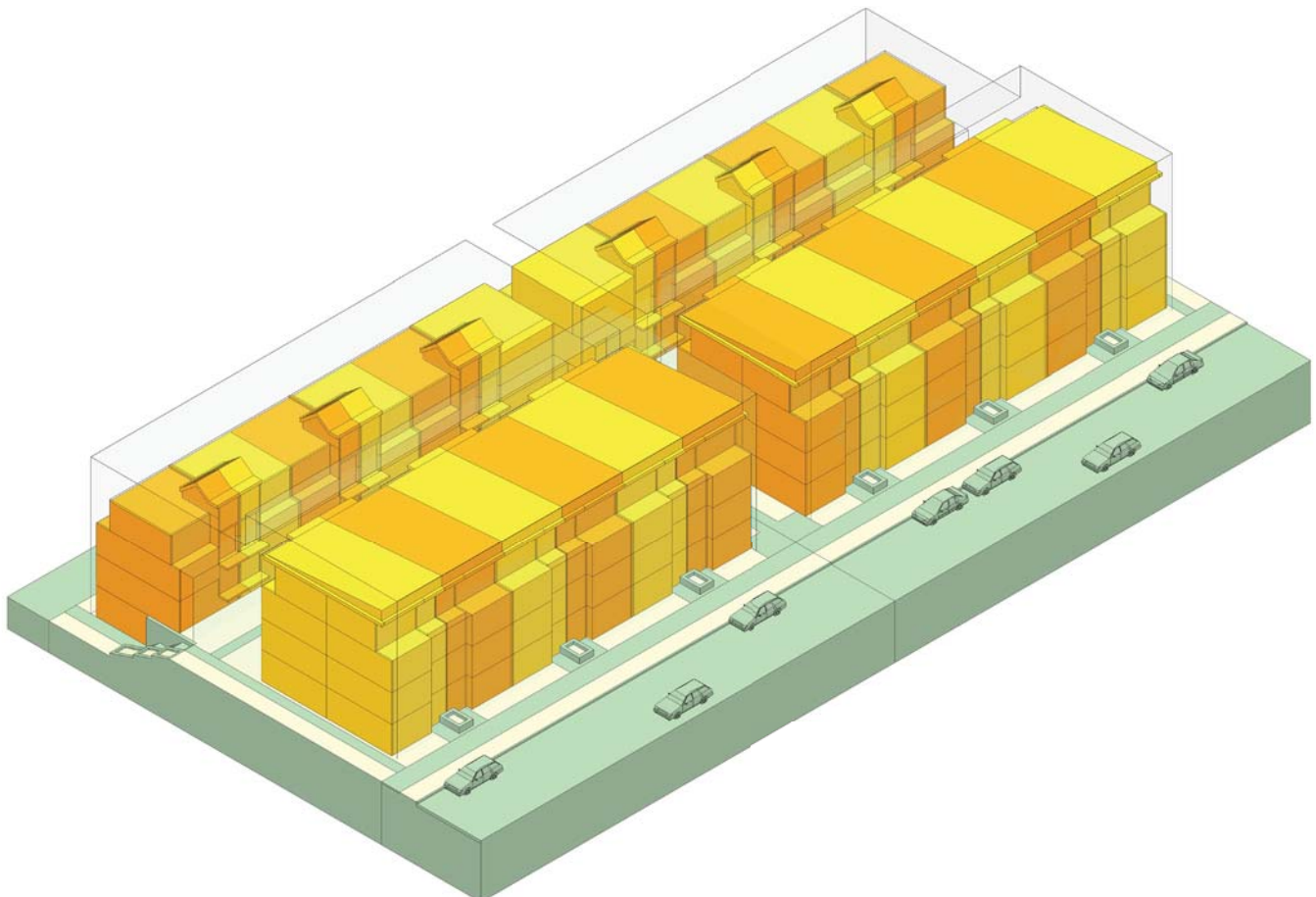
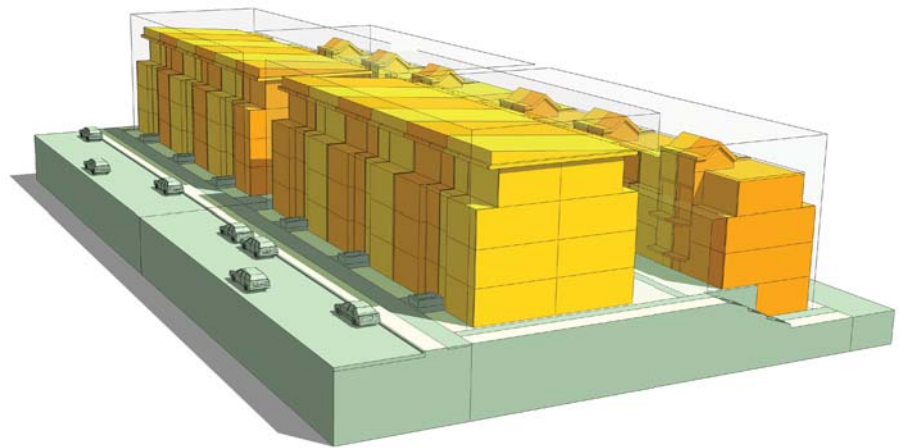

10.7 RM-2 1.60 FSR APARTMENT

