



528 E 7TH ST. NORTH VANCOUVER

- A100 - SITE PLAN
- A101 - FOUNDATION PLAN
- A102 - BASEMENT FLOOR PLAN
- A103 - MAIN FLOOR PLAN
- A104 - 2ND FLOOR PLAN
- A105 - ROOF PLAN
- A106 - ELEVATIONS - EAST & WEST
- A107 - ELEVATIONS - NORTH & SOUTH
- A108 - SECTIONS & ASSEMBLIES
- A109 - DETAILS
- A110 - F.A.R
- A111 - GARAGE

WWW.ROBERTBLANEYDESIGN.COM

604-626-6020

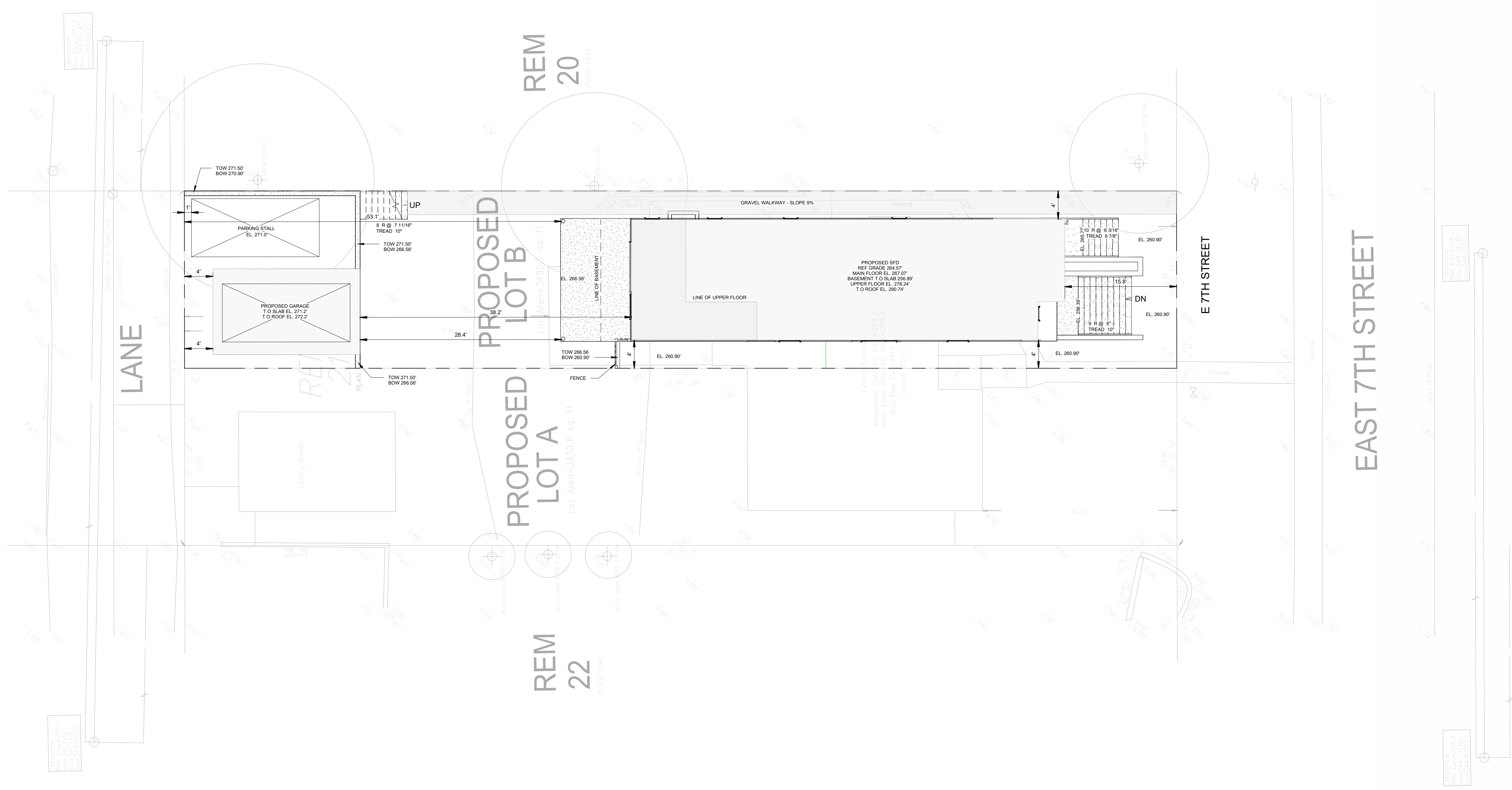
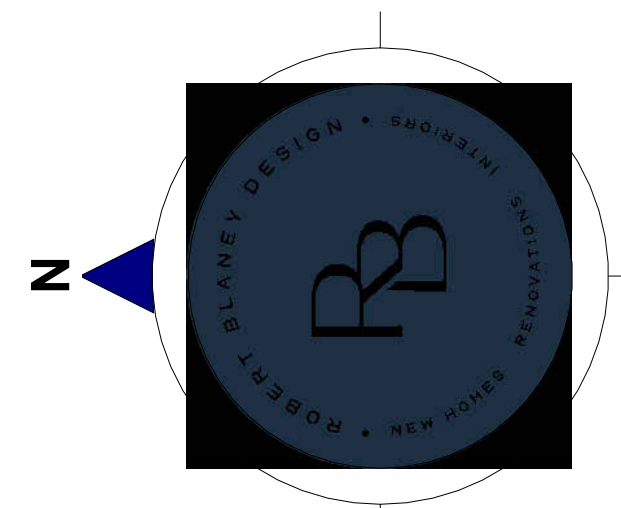

1 SITE
1/8" = 1'-0"

PROJECT STATISTICS				
SITE STATISTICS				
CIVIC ADDRESS:	528 E 7TH ST. NORTH VANCOUVER			
LEGAL DESCRIPTION:	LOT 21, EXCEPT THE NORTH 10 FEET NOW LANE, BLOCK 2 DISTRICT LOT 273 GROUP 1 NWD PLAN 1063			
P.I.D.:	014-888-777			
ZONE:	CNV RS2			
SITE AREA (SQ.FT.):	3,492			
SITE WIDTH (FT):	24.99			
REFERENCE GRADE:	264.57			
PROJECT STATISTICS				
HOUSE	PERMITTED/REQUIRED		PROPOSED	
	IMPERIAL	METRIC	IMPERIAL	METRIC
TOP PLATE HEIGHT	26.2	7.99	25.17	7.67
BUILDING HEIGHT	33.1	10.09	26.19	7.98
FRONT YARD SETBACK (S)	15	4.57	15.8	4.82
EAST SIDE YARD SETBACK	4	1.22	4	1.22
WEST SIDE YARD SETBACK	4	1.22	4	1.22
REAR YARD SETBACK (N)	26.2	7.99	53.1	16.18
ACCESSORY BUILDING	PERMITTED/REQUIRED		PROPOSED	
	IMPERIAL	METRIC	IMPERIAL	METRIC
BUILDING HEIGHT	12	3.66	0	0.00
FROM PRINCIPAL BUILDING (S)	10	3.05	28.4	8.66
EAST SIDE YARD SETBACK	2	0.61	2	0.61
WEST SIDE YARD SETBACK	2	0.61	10.9	3.32
REAR YARD SETBACK (N)	4	1.22	4	1.22
FLOOR AREAS				
	PERMITTED/REQUIRED		PROPOSED	
	AREA (SF)	AREA (M2)	AREA (SF)	AREA (M2)
FLOOR				
BASEMENT			1075.3	99.90
MAIN FLOOR			908.1	84.36
2ND FLOOR			831.9	
ACCESSORY			249.8	23.21
TOTAL SQ.FT.	1746	162.20	3065.1	284.75
G.F.A EXEMPTIONS				
	PERMITTED/REQUIRED		PROPOSED	
	AREA (SF)	AREA (M2)	AREA (SF)	AREA (M2)
EXEMPTION				
BASEMENT			1075.3	99.90
ACCESSORY (MAX 600 SF)			249.8	
TOTAL EXEMPT FROM GFA			1325.1	123.10
G.F.A				
	PERMITTED/REQUIRED		PROPOSED	
	AREA (SF)	AREA (M2)	AREA (SF)	AREA (M2)
TOTAL G.F.A	SITE AREA x 50% 1746sf (162.2m2)		1740	161.65
SITE COVERAGE - HOUSE				
	PERMITTED/REQUIRED		PROPOSED	
	AREA (SF)	AREA (M2)	AREA (SF)	AREA (M2)
AREA OF HOUSE			908.1	84.36
TOTAL SITE COVERAGE (MAX 30%)	1047.582	97.32	908.1	84.36
SITE COVERAGE - ACCESSORY BUILDINGS & HOUSE				
	PERMITTED/REQUIRED		PROPOSED	
	AREA (SF)	AREA (M2)	AREA (SF)	AREA (M2)
AREA OF ACCESSORY			249.8	23.21
AREA OF HOUSE			908.1	84.36
TOTAL SITE COVERAGE (MAX 40%)	1396.776	129.76	1157.9	107.57

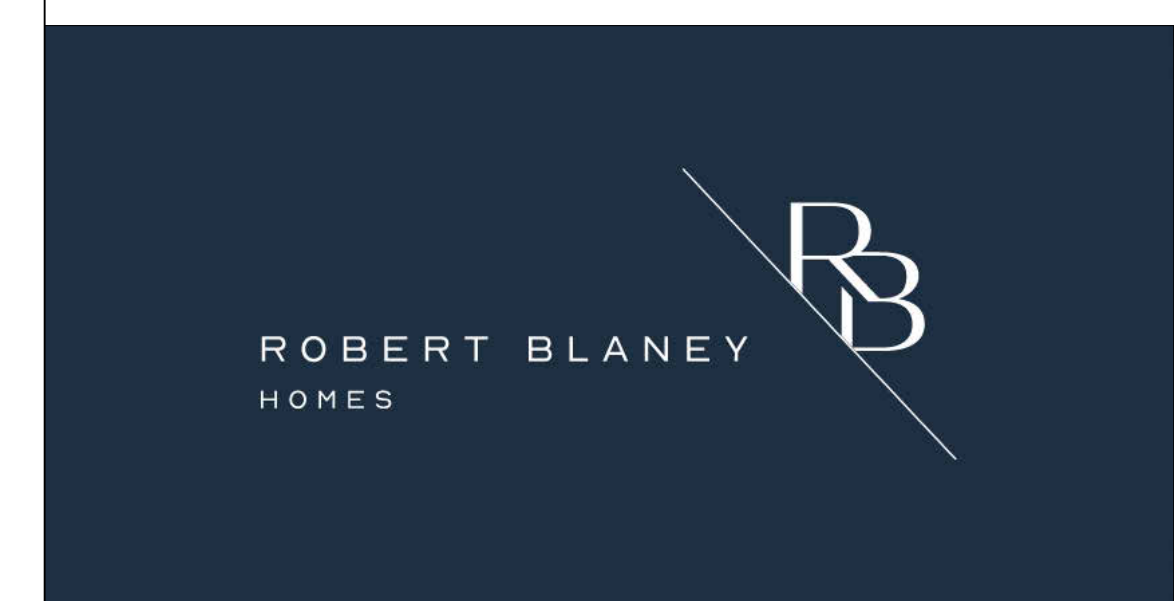

5464 PATRICIA BAY HIGHWAY,
VICTORIA BC V8Y 2N9

(604) 626-6020
ROBERTBLANEYDESIGN@GMAIL.COM
WWW.ROBERTBLANEYDESIGN.COM

REVISIONS
ISSUED FOR:
REVIEW SET: 01/23/07

PROJECT:
NAME
ADDRESS 528 EAST 7TH STR
CITY NORTH VANCOUVER

DRAWING TITLE:
SITE PLAN

SHEET:

A100

DRAWN BY: SDP

24X36 SCALE: 1/8" = 1'-0"
PROJECT NUMBER: Project Number
START DATE:

COPYRIGHT RESERVED.
THIS DRAWING AND DESIGN ARE AND SHALL AT ALL TIMES REMAIN THE EXCLUSIVE PROPERTY OF ROBERT BLANEY DESIGN AND CANNOT BE USED OR REPRODUCED WITHOUT WRITTEN CONSENT. WRITTEN DIMENSIONS SHALL HAVE PRECEDENCE OVER SCALED DIMENSIONS. CONTRACTOR SHALL VERIFY AND SHALL BE RESPONSIBLE FOR ALL DIMENSIONS AND CONDITIONS ON THE JOB AND THIS OFFICE SHALL BE INFORMED OF ANY VARIATIONS FROM THE DIMENSIONS AND CONDITIONS AS SHOWN ON THIS DRAWING. CONTRACTORS SHALL ENSURE THAT ALL CONSTRUCTION WILL COMPLY TO ALL APPLICABLE BUILDING CODES. ROBERT BLANEY DESIGN WILL NOT ACCEPT RESPONSIBILITY FOR VARIATIONS OR MODIFICATION OF THESE PLANS.

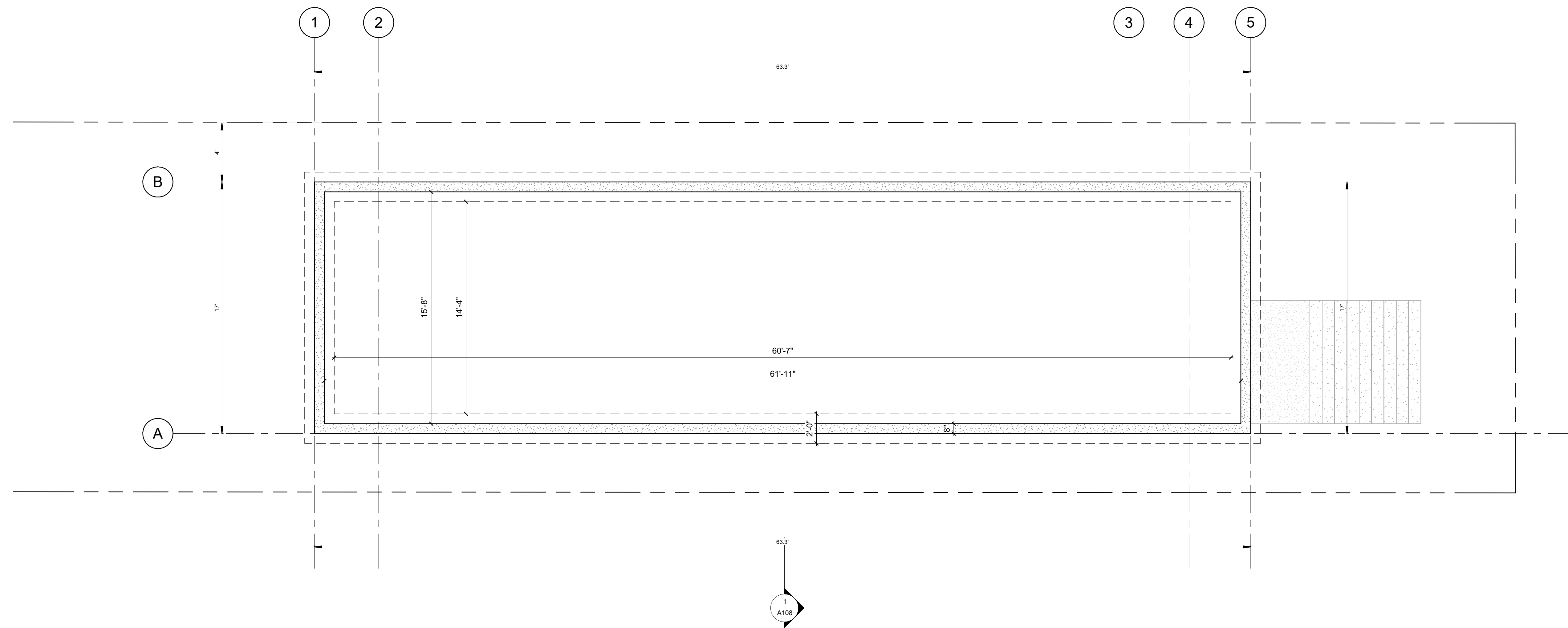
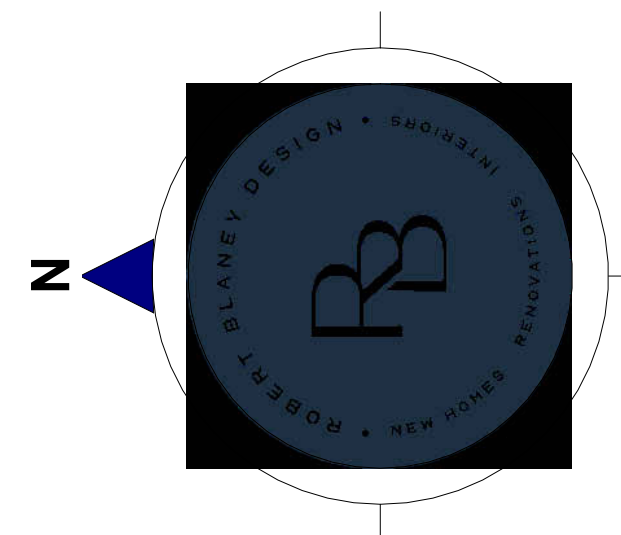

1 FOUNDATION
1/4" = 1'-0"



5464 PATRICIA BAY HIGHWAY,
VICTORIA BC V8Y 2N9

(604) 626-6020
ROBERTBLANEYDESIGN@GMAIL.COM
WWW.ROBERTBLANEYDESIGN.COM

REVISIONS
ISSUED FOR:
REVIEW SET: 01/23/07

PROJECT:
NAME
ADDRESS 528 EAST 7TH STR
CITY NORTH VANCOUVER

DRAWING TITLE:
FOUNDATION

SHEET:
A101

DRAWN BY: SDP

24X36 SCALE:
1/4" = 1'-0"

START DATE:

PROJECT NUMBER:
Project Number

COPYRIGHT RESERVED.
THIS DRAWING AND DESIGN ARE AND SHALL AT ALL TIMES REMAIN THE EXCLUSIVE PROPERTY OF ROBERT BLANEY DESIGN AND CANNOT BE USED OR REPRODUCED WITHOUT WRITTEN CONSENT. WRITTEN DIMENSIONS SHALL HAVE PRECEDENCE OVER SCALED DIMENSIONS. CONTRACTOR SHALL VERIFY AND SHALL BE RESPONSIBLE FOR ALL DIMENSIONS AND CONDITIONS ON THE JOB AND THIS OFFICE SHALL BE INFORMED OF ANY VARIATIONS FROM THE DIMENSIONS AND CONDITIONS AS SHOWN ON THIS DRAWING. CONTRACTORS SHALL ENSURE THAT ALL CONSTRUCTION WILL COMPLY TO ALL APPLICABLE BUILDING CODES. ROBERT BLANEY DESIGN WILL NOT ACCEPT RESPONSIBILITY FOR VARIATIONS OR MODIFICATION OF THESE PLANS.

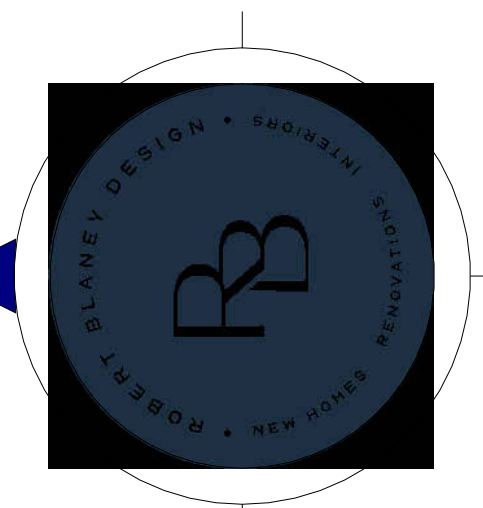

Window Schedule BASEMENT				
Level	Mark	Width	Height	Sill Height
BASEMENT	W12	5'-0"	3'-6"	4'-6"
BASEMENT	W13	5'-0"	3'-6"	4'-6"
BASEMENT	W14	5'-0"	3'-6"	4'-6"
BASEMENT	W17	5'-0"	3'-6"	4'-6"

Door Schedule BASEMENT			
Level	Mark	Width	Height
BASEMENT	8	2'-2"	8'-0"
BASEMENT	11	2'-2"	8'-0"
BASEMENT	13	2'-2"	8'-0"
BASEMENT	14	2'-6"	8'-0"
BASEMENT	23	7'-0"	8'-0"
BASEMENT	29	2'-8"	8'-0"
BASEMENT	30	2'-2"	8'-0"
BASEMENT	32	2'-6"	8'-0"
BASEMENT	34	2'-6"	8'-0"
BASEMENT	35	3'-0"	7'-0"
BASEMENT	36	2'-6"	8'-0"

Room Schedule BASEMENT			
Level	Name	Area	Perimeter
BASEMENT	BATH	38 ft ²	25'-1"
BASEMENT	CLOSET	12 ft ²	13'-11 3/4"
BASEMENT	FLEX	147 ft ²	49'-4"
BASEMENT	KITCHEN	76 ft ²	37'-10"
BASEMENT	LIVING ROOM	175 ft ²	56'-10"
BASEMENT	MECHANICAL	30 ft ²	23'-0 1/2"
BASEMENT	PANTRY	13 ft ²	14'-4 1/2"
BASEMENT	PASSAGE	81 ft ²	57'-3"
BASEMENT	SUITE BEDROOM 1	109 ft ²	41'-9"
BASEMENT	SUITE BEDROOM 2	89 ft ²	38'-7 1/2"
BASEMENT	SUITE PASSAGE	52 ft ²	40'-7 1/2"

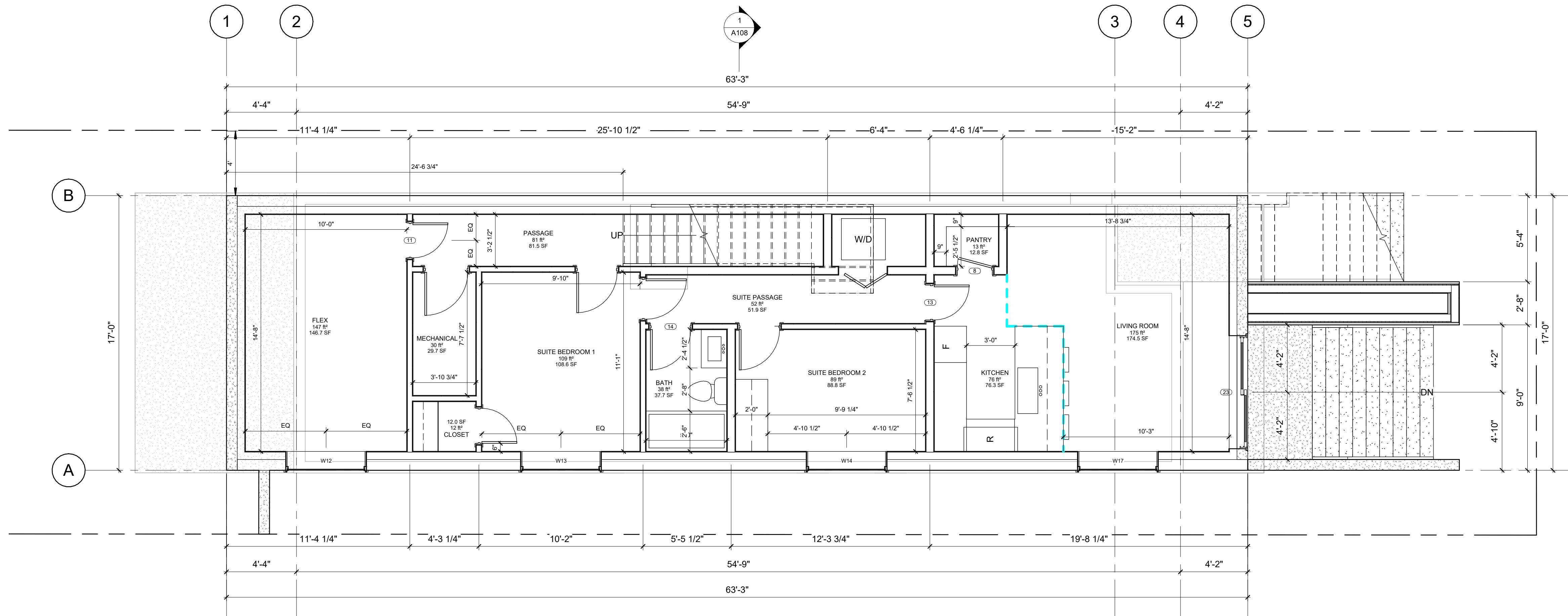

1 BASEMENT
1/4" = 1'-0"



5464 PATRICIA BAY HIGHWAY,
VICTORIA BC V8Y 2N9

(604) 626-6020
ROBERTBLANEYDESIGN@GMAIL.COM
WWW.ROBERTBLANEYDESIGN.COM

REVISIONS
ISSUED FOR:
REVIEW SET: 03/06/21

PROJECT:
NAME
ADDRESS 528 EAST 7TH STR
CITY NORTH VANCOUVER

DRAWING TITLE:
BASEMENT FLOOR PLAN

SHEET:
A102

DRAWN BY: SDP

24X36 SCALE: 1/4" = 1'-0"
PROJECT NUMBER: Project Number
START DATE:

COPYRIGHT RESERVED.
THIS DRAWING AND DESIGN ARE AND SHALL AT ALL TIMES REMAIN THE EXCLUSIVE PROPERTY OF ROBERT BLANEY DESIGN AND CANNOT BE USED OR REPRODUCED WITHOUT WRITTEN CONSENT. WRITTEN DIMENSIONS SHALL HAVE PRECEDENCE OVER SCALED DIMENSIONS. CONTRACTOR SHALL VERIFY AND SHALL BE RESPONSIBLE FOR ALL DIMENSIONS AND CONDITIONS ON THE JOB AND THIS OFFICE SHALL BE INFORMED OF ANY VARIATIONS FROM THE DIMENSIONS AND CONDITIONS AS SHOWN ON THIS DRAWING. CONTRACTORS SHALL ENSURE THAT ALL CONSTRUCTION WILL COMPLY TO ALL APPLICABLE BUILDING CODES. ROBERT BLANEY DESIGN WILL NOT ACCEPT RESPONSIBILITY FOR VARIATIONS OR MODIFICATION OF THESE PLANS.

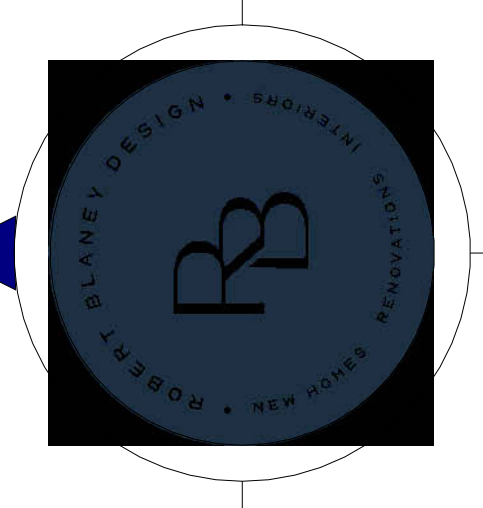

Window Schedule MAIN FLOOR				
Level	Mark	Width	Height	Sill Height
MAIN FLOOR	W1	2'-0"	6'-0"	2'-0"
MAIN FLOOR	W2	2'-0"	6'-0"	2'-0"
MAIN FLOOR	W3	6'-0"	8'-0"	1'-0"
MAIN FLOOR	W4	4'-0"	5'-0"	3'-0"
MAIN FLOOR	W5	2'-0"	2'-0"	6'-0"
MAIN FLOOR	W11	2'-0"	2'-0"	6'-0"

Door Schedule MAIN FLOOR			
Level	Mark	Width	Height
MAIN FLOOR	2	3'-0"	9'-0"
MAIN FLOOR	21	2'-2"	8'-0"
MAIN FLOOR	25	11'-0"	8'-0"
MAIN FLOOR	40	2'-2"	8'-0"

Room Schedule MAIN FLOOR			
Level	Name	Area	Perimeter
MAIN FLOOR	LIVING	155 ft ²	60'-11 1/2"
MAIN FLOOR	PANTRY	22 ft ²	18'-8 3/4"
MAIN FLOOR	KITCHEN	195 ft ²	59'-10 3/4"
MAIN FLOOR	FAMILY	234 ft ²	61'-3 1/4"
MAIN FLOOR	POWDER	26 ft ²	20'-3"
MAIN FLOOR	DINING	186 ft ²	57'-6 1/2"

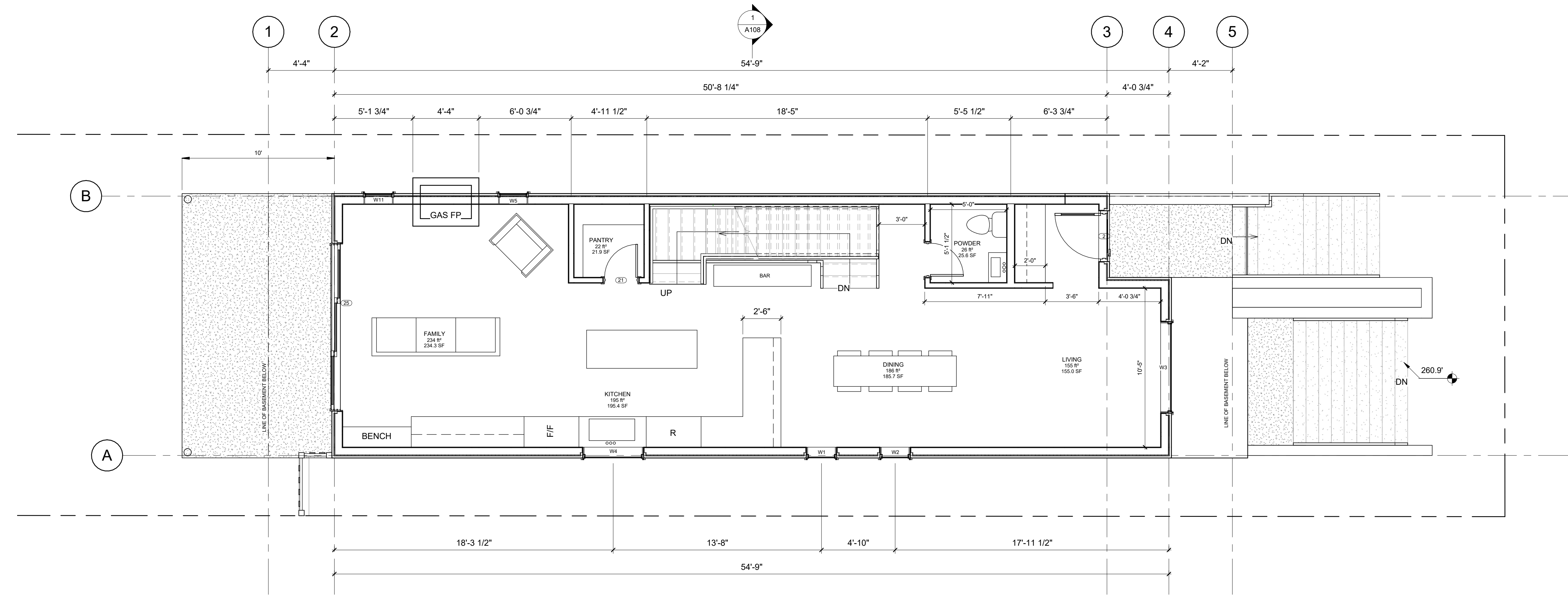

1 MAIN FLOOR
1/4" = 1'-0"

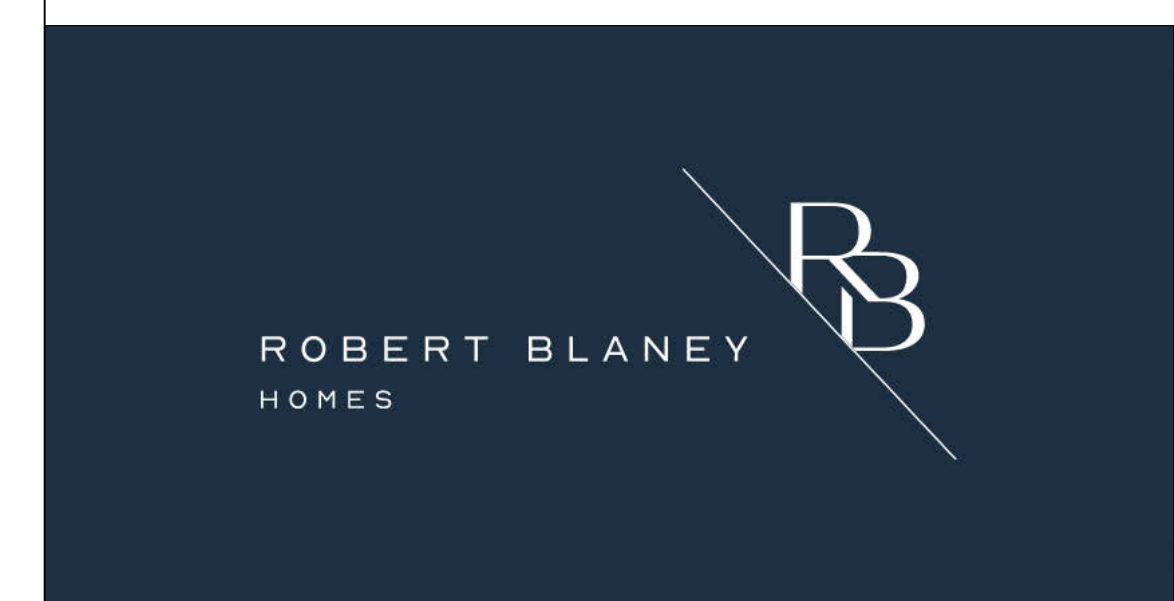

5464 PATRICIA BAY HIGHWAY,
VICTORIA BC V8Y 2N9

(604) 626-6020
ROBERTBLANEYDESIGN@GMAIL.COM
WWW.ROBERTBLANEYDESIGN.COM

REVISIONS
ISSUED FOR:
REVIEW SET: 03/06/21

PROJECT:
NAME
ADDRESS 528 EAST 7TH STR
CITY NORTH VANCOUVER

DRAWING TITLE:
MAIN FLOOR PLAN

SHEET:

A103

DRAWN BY: SDP

24X36 SCALE:
1/4" = 1'-0"

START DATE:

PROJECT NUMBER:
Project Number

COPYRIGHT RESERVED.

THIS DRAWING AND DESIGN ARE AND SHALL AT ALL TIMES REMAIN THE EXCLUSIVE PROPERTY OF ROBERT BLANEY DESIGN AND CANNOT BE USED OR REPRODUCED WITHOUT WRITTEN CONSENT. WRITTEN DIMENSIONS SHALL HAVE PRECEDENCE OVER SCALED DIMENSIONS. CONTRACTOR SHALL VERIFY AND SHALL BE RESPONSIBLE FOR ALL DIMENSIONS AND CONDITIONS ON THE JOB AND THIS OFFICE SHALL BE INFORMED OF ANY VARIATIONS FROM THE DIMENSIONS AND CONDITIONS AS SHOWN ON THIS DRAWING. CONTRACTORS SHALL ENSURE THAT ALL CONSTRUCTION WILL COMPLY TO ALL APPLICABLE BUILDING CODES. ROBERT BLANEY DESIGN WILL NOT ACCEPT RESPONSIBILITY FOR VARIATIONS OR MODIFICATION OF THESE PLANS.

Window Schedule 2ND FLOOR				
Level	Mark	Width	Height	Sill Height
2ND FLOOR	W7	5'-0"	5'-0"	3'-0"
2ND FLOOR	W8	3'-0"	3'-0"	5'-0"
2ND FLOOR	W9	2'-0"	2'-0"	6'-0"
2ND FLOOR	W10	2'-0"	2'-0"	6'-0"
2ND FLOOR	W15	6'-0"	5'-0"	3'-0"
2ND FLOOR	W16	3'-0"	3'-0"	5'-0"
2ND FLOOR	W18	3'-0"	3'-0"	5'-0"
2ND FLOOR	W19	2'-0"	6'-0"	2'-0"

Door Schedule 2ND FLOOR			
Level	Mark	Width	Height
2ND FLOOR	9	2'-6"	8'-0"
2ND FLOOR	10	2'-8"	8'-0"
2ND FLOOR	15	2'-8"	8'-0"
2ND FLOOR	16	2'-6"	8'-0"
2ND FLOOR	17	2'-2"	8'-0"
2ND FLOOR	19	2'-6"	8'-0"
2ND FLOOR	38	2'-6"	8'-0"
2ND FLOOR	41	6'-0"	8'-0"

Room Schedule 2ND FLOOR			
Level	Name	Area	Perimeter
2ND FLOOR	BATH	51 ft ²	30'-4"
2ND FLOOR	BEDROOM 1	125 ft ²	49'-0"
2ND FLOOR	BEDROOM 2	106 ft ²	45'-10"
2ND FLOOR	CLOSET	41 ft ²	26'-5"
2ND FLOOR	PASSAGE	160 ft ²	74'-9 3/4"
2ND FLOOR	PRIMARY BATH	82 ft ²	37'-5"
2ND FLOOR	PRIMARY BED	144 ft ²	54'-7"

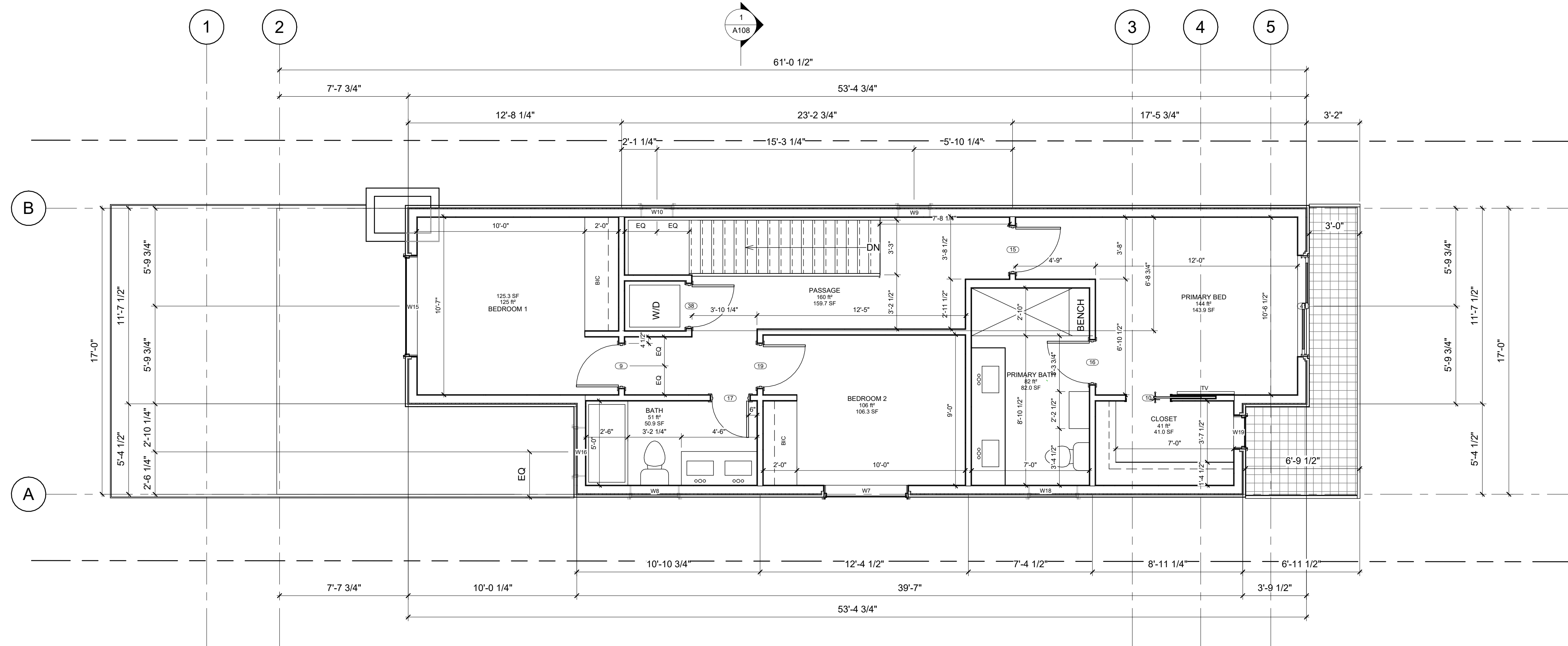
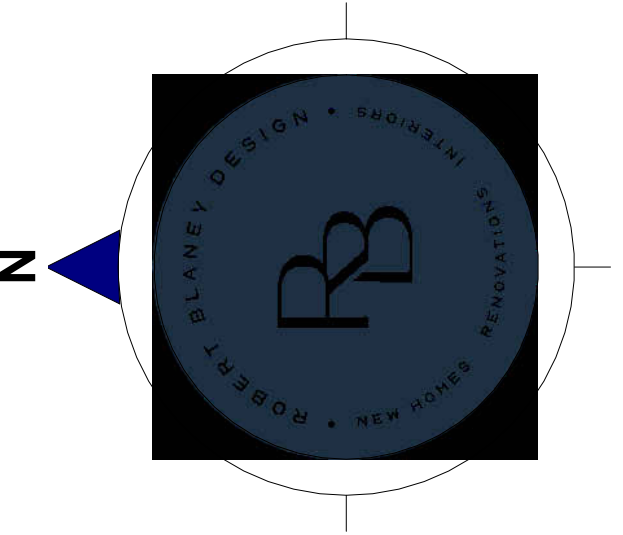

1 2ND FLOOR
1/4" = 1'-0"



5464 PATRICIA BAY HIGHWAY,
VICTORIA BC V8Y 2N9

(604) 626-6020
ROBERTBLANEYDESIGN@GMAIL.COM
WWW.ROBERTBLANEYDESIGN.COM

REVISIONS
ISSUED FOR:
REVIEW SET: 05/24/21

PROJECT:
NAME
ADDRESS 528 EAST 7TH STR
CITY NORTH VANCOUVER

DRAWING TITLE:
2ND FLOOR PLAN

SHEET:
A104

DRAWN BY: SDP

24X36 SCALE:
1/4" = 1'-0"

START DATE:

PROJECT NUMBER:
Project Number

COPYRIGHT RESERVED.

THIS DRAWING AND DESIGN ARE AND SHALL AT ALL TIMES REMAIN THE EXCLUSIVE PROPERTY OF ROBERT BLANEY DESIGN AND CANNOT BE USED OR REPRODUCED WITHOUT WRITTEN CONSENT. WRITTEN DIMENSIONS SHALL HAVE PRECEDENCE OVER SCALED DIMENSIONS. CONTRACTOR SHALL VERIFY AND SHALL BE RESPONSIBLE FOR ALL DIMENSIONS AND CONDITIONS ON THE JOB AND THIS OFFICE SHALL BE INFORMED OF ANY VARIATIONS FROM THE DIMENSIONS AND CONDITIONS AS SHOWN ON THIS DRAWING. CONTRACTORS SHALL ENSURE THAT ALL CONSTRUCTION WILL COMPLY TO ALL APPLICABLE BUILDING CODES. ROBERT BLANEY DESIGN WILL NOT ACCEPT RESPONSIBILITY FOR VARIATIONS OR MODIFICATION OF THESE PLANS.

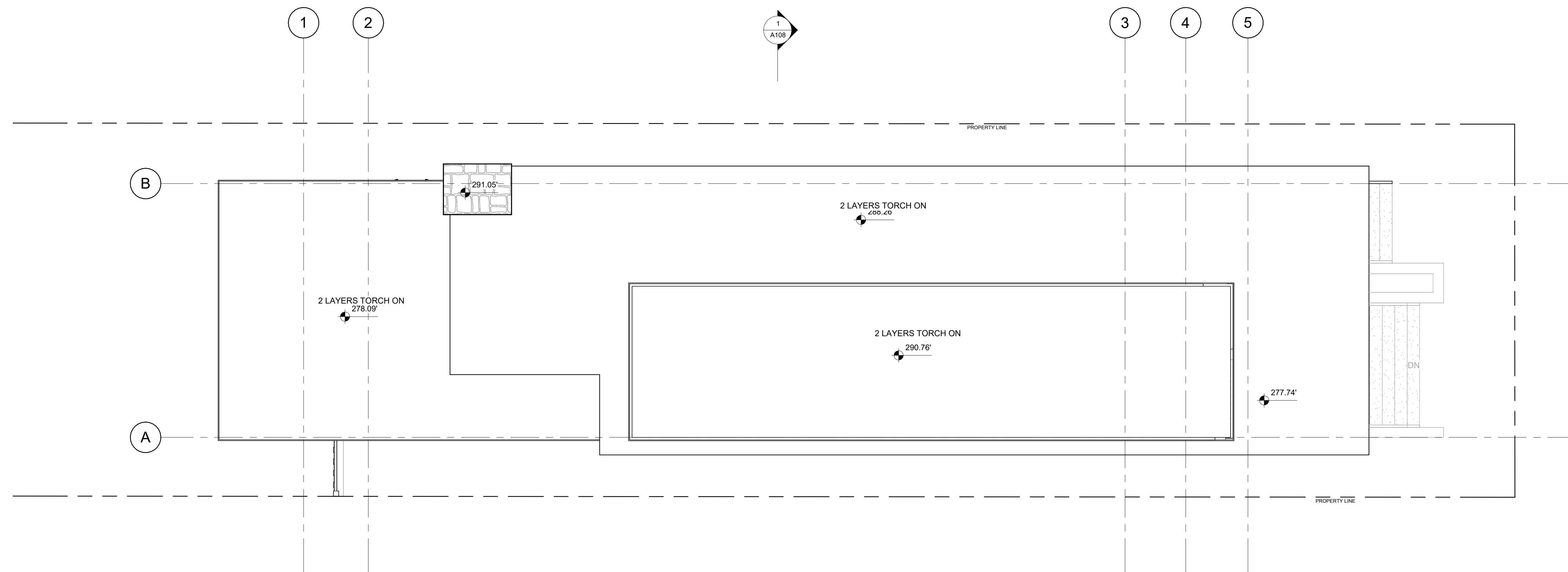
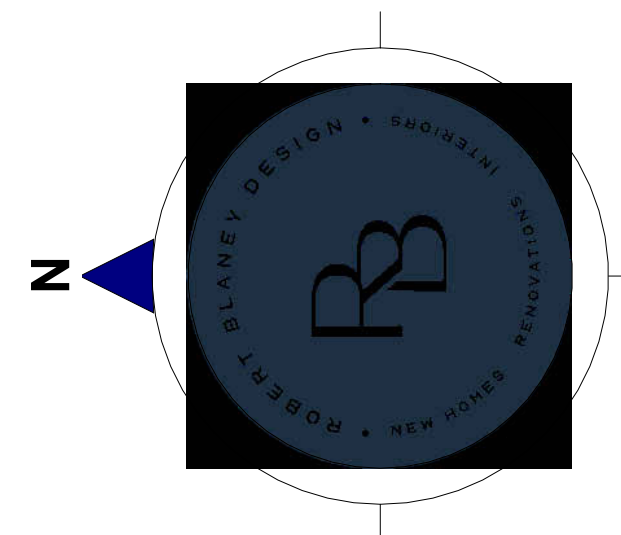

1 ROOF
1/4" = 1'-0"



5464 PATRICIA BAY HIGHWAY,
VICTORIA BC V8Y 2N9

(604) 626-6020
ROBERTBLANEYDESIGN@GMAIL.COM
WWW.ROBERTBLANEYDESIGN.COM

REVISIONS
ISSUED FOR:
REVIEW SET: 03/06/21

PROJECT:
NAME
ADDRESS 528 EAST 7TH STR
CITY NORTH VANCOUVER

SHEET:
A105

DRAWN BY: SDP

24X36 SCALE:
1/4" = 1'-0"

PROJECT NUMBER:
Project Number

START DATE:

DRAWING TITLE:
ROOF PLAN

COPYRIGHT RESERVED.
THIS DRAWING AND DESIGN ARE AND SHALL AT ALL TIMES REMAIN THE EXCLUSIVE PROPERTY OF ROBERT BLANEY DESIGN AND CANNOT BE USED OR REPRODUCED WITHOUT WRITTEN CONSENT. WRITTEN DIMENSIONS SHALL HAVE PRECEDENCE OVER SCALED DIMENSIONS. CONTRACTOR SHALL VERIFY AND SHALL BE RESPONSIBLE FOR ALL DIMENSIONS AND CONDITIONS ON THE JOB AND THIS OFFICE SHALL BE INFORMED OF ANY VARIATIONS FROM THE DIMENSIONS AND CONDITIONS AS SHOWN ON THIS DRAWING. CONTRACTORS SHALL ENSURE THAT ALL CONSTRUCTION WILL COMPLY TO ALL APPLICABLE BUILDING CODES. ROBERT BLANEY DESIGN WILL NOT ACCEPT RESPONSIBILITY FOR VARIATIONS OR MODIFICATION OF THESE PLANS.



MAIN FLOOR
 MAIN FLOOR
 MAIN FLOOR
 2ND FLOOR
 2ND FLOOR
 2ND FLOOR
 2ND FLOOR
 2ND FLOOR
 MAIN FLOOR
 BASEMENT
 BASEMENT
 BASEMENT
 2ND FLOOR
 BASEMENT
 2ND FLOOR
 2ND FLOOR

Level
MAIN FLOOR
BASEMENT
GARAGE T.O SLAB
2ND FLOOR

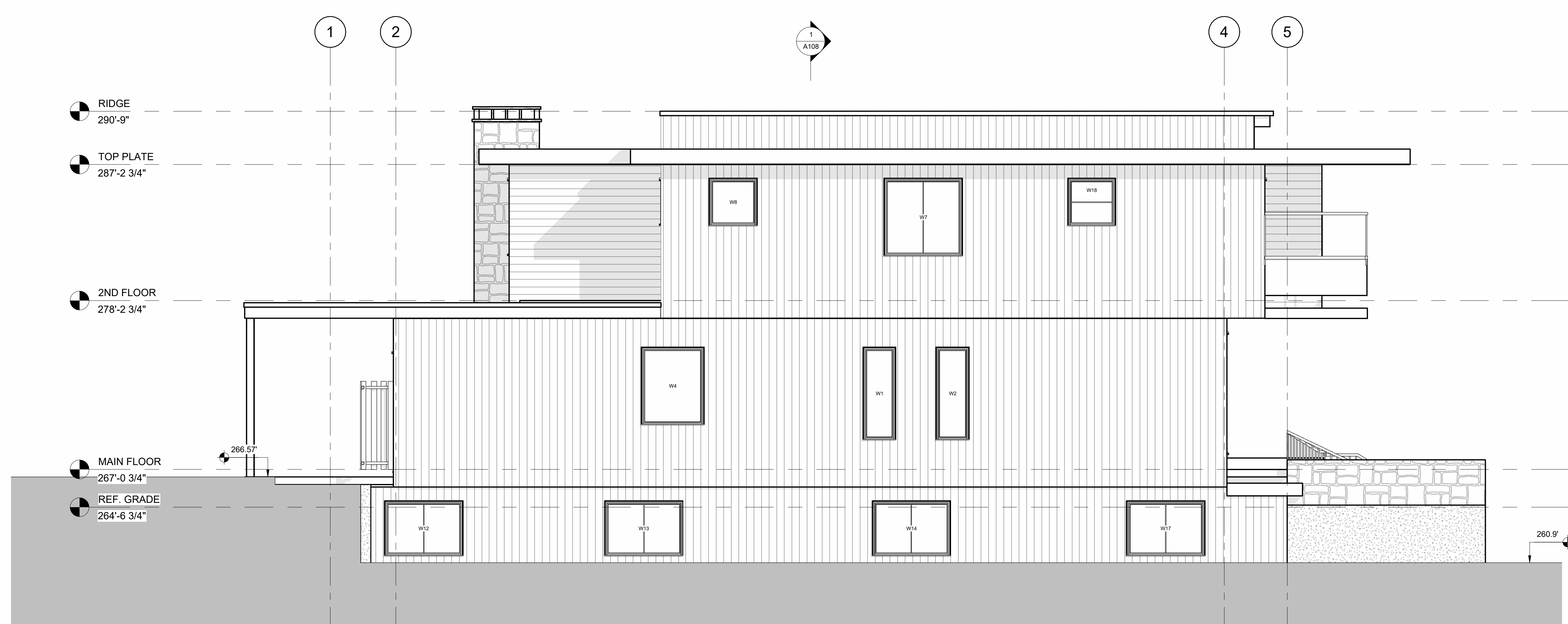

RIDGE
 290'-9"
 TOP PLATE
 287'-2 3/4"
 2ND FLOOR
 278'-2 3/4"
 MAIN FLOOR
 267'-0 3/4"
 REF. GRADE
 264'-6 3/4"

F

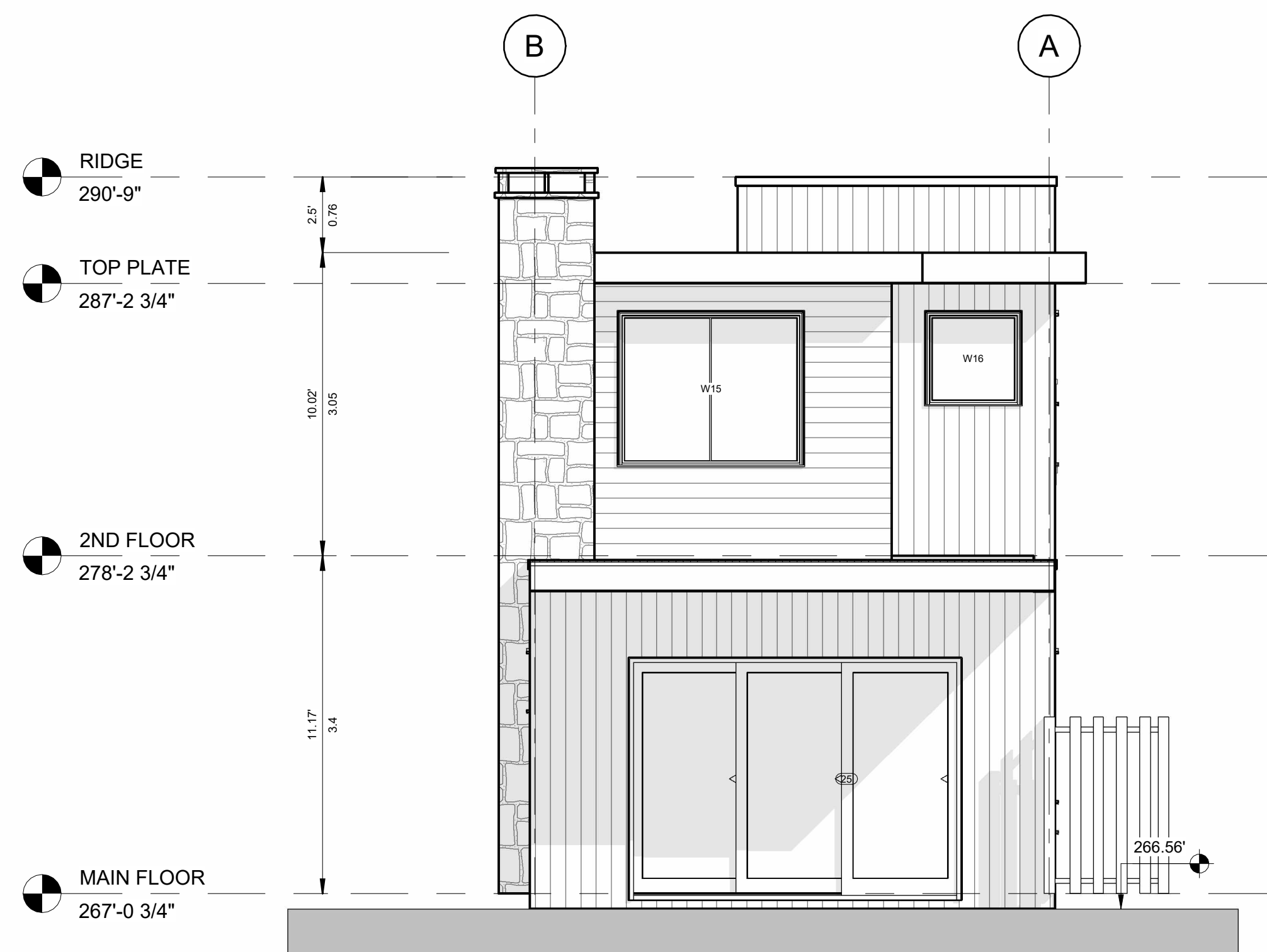
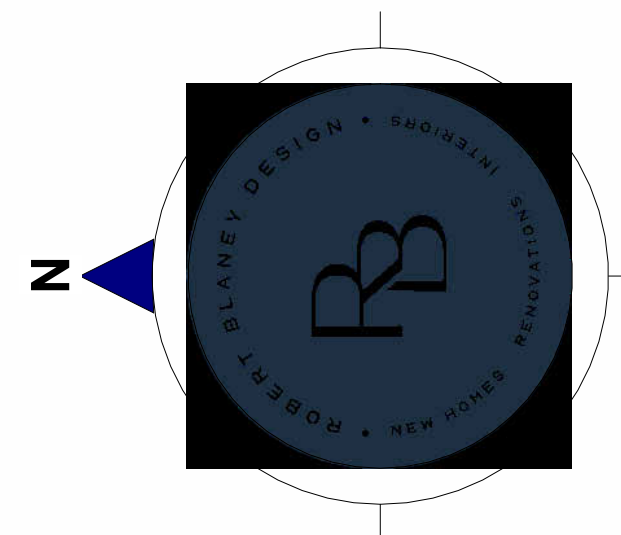

1 North
1/4" = 1'-0"

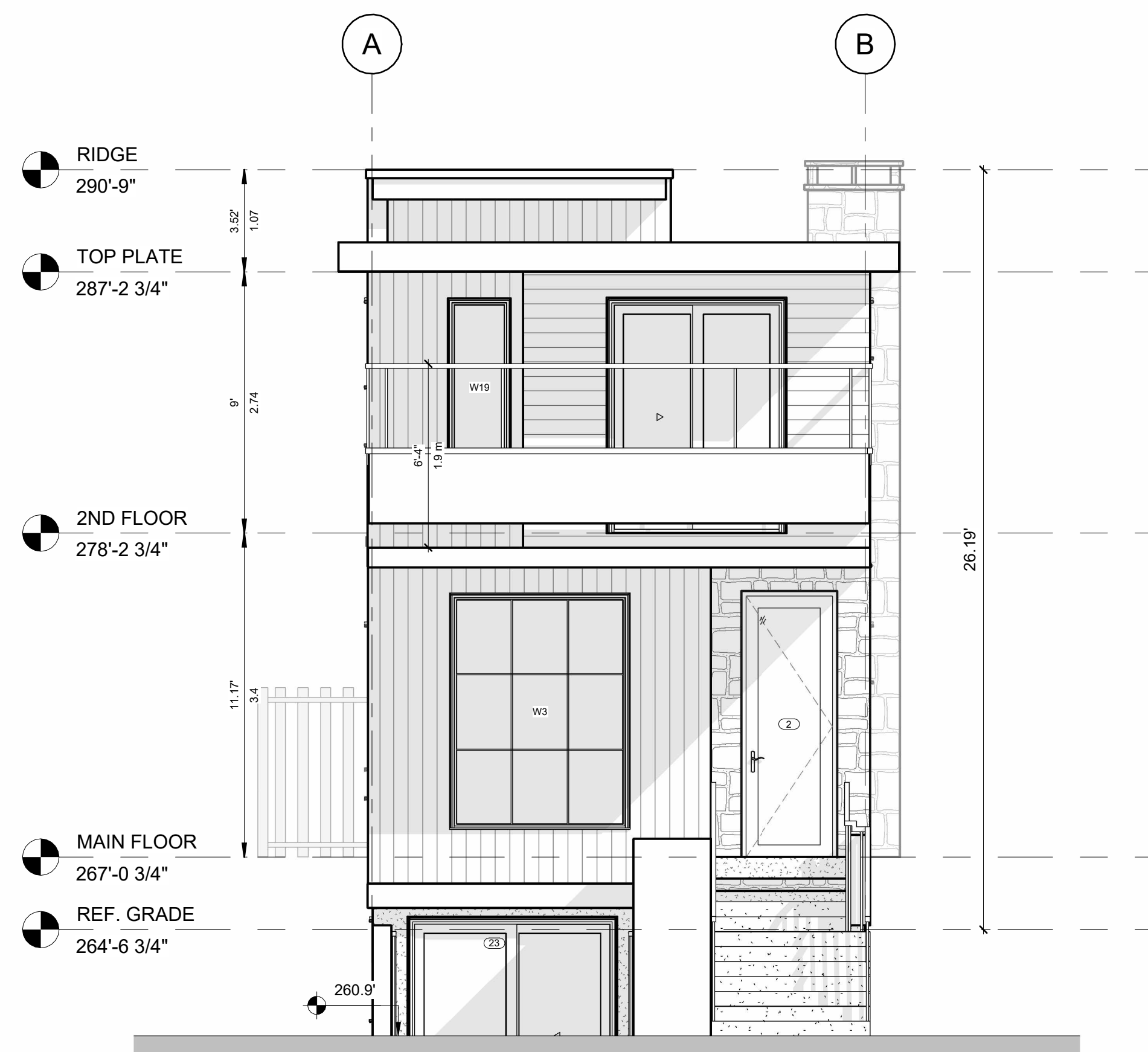

2 South
1/4" = 1'-0"

LEGEND	
HARDIE SHAKES (WHITE)	A
STONE (TBD)	B
ASPHALT SHINGLES	C
STANDING SEAM METAL	D

Door Schedule EXTERIOR				
Level	Mark	Width	Height	Function
MAIN FLOOR	2	3'-0"	9'-0"	Exterior
BASEMENT	23	7'-0"	8'-0"	Exterior
GARAGE T.O SLAB	28	3'-0"	6'-8"	Exterior
2ND FLOOR	41	6'-0"	8'-0"	Exterior

Window Schedule ALL FLOORS					
Level	Mark	Sill Height	Width	Height	Area
MAIN FLOOR	W1	2'-0"	2'-0"	6'-0"	12 ft ²
MAIN FLOOR	W2	2'-0"	2'-0"	6'-0"	12 ft ²
MAIN FLOOR	W3	1'-0"	6'-0"	8'-0"	48 ft ²
MAIN FLOOR	W4	3'-0"	4'-0"	5'-0"	20 ft ²
MAIN FLOOR	W5	6'-0"	2'-0"	2'-0"	4 ft ²
2ND FLOOR	W7	3'-0"	5'-0"	5'-0"	25 ft ²
2ND FLOOR	W8	5'-0"	3'-0"	3'-0"	9 ft ²
2ND FLOOR	W9	6'-0"	2'-0"	2'-0"	4 ft ²
2ND FLOOR	W10	6'-0"	2'-0"	2'-0"	4 ft ²
MAIN FLOOR	W11	6'-0"	2'-0"	2'-0"	4 ft ²
BASEMENT	W12	4'-6"	5'-0"	3'-6"	18 ft ²
BASEMENT	W13	4'-6"	5'-0"	3'-6"	18 ft ²
BASEMENT	W14	4'-6"	5'-0"	3'-6"	18 ft ²
2ND FLOOR	W15	3'-0"	6'-0"	5'-0"	30 ft ²
2ND FLOOR	W16	5'-0"	3'-0"	3'-0"	9 ft ²
BASEMENT	W17	4'-6"	5'-0"	3'-6"	18 ft ²
2ND FLOOR	W18	5'-0"	3'-0"	3'-0"	9 ft ²
2ND FLOOR	W19	2'-0"	2'-0"	6'-0"	12 ft ²



5464 PATRICIA BAY HIGHWAY,
VICTORIA BC V8Y 2N9

(604) 626-6020
ROBERTBLANEYDESIGN@GMAIL.COM
WWW.ROBERTBLANEYDESIGN.COM

REVISIONS
ISSUED FOR:
REVIEW SET: 03/06/21

PROJECT:
NAME
ADDRESS 528 EAST 7TH STR
CITY NORTH VANCOUVER

DRAWING TITLE:
ELEVATIONS - NORTH & SOUTH

SHEET:
A107

DRAWN BY: SDP

24X36 SCALE: 1/4" = 1'-0"
PROJECT NUMBER: Project Number
START DATE:

COPYRIGHT RESERVED.
THIS DRAWING AND DESIGN ARE AND SHALL AT ALL TIMES REMAIN THE EXCLUSIVE PROPERTY OF ROBERT BLANEY DESIGN AND CANNOT BE USED OR REPRODUCED WITHOUT WRITTEN CONSENT. WRITTEN DIMENSIONS SHALL HAVE PRECEDENCE OVER SCALED DIMENSIONS. CONTRACTOR SHALL VERIFY AND SHALL BE RESPONSIBLE FOR ALL DIMENSIONS AND CONDITIONS ON THE JOB AND THIS OFFICE SHALL BE INFORMED OF ANY VARIATIONS FROM THE DIMENSIONS AND CONDITIONS AS SHOWN ON THIS DRAWING. CONTRACTORS SHALL ENSURE THAT ALL CONSTRUCTION WILL COMPLY TO ALL APPLICABLE BUILDING CODES. ROBERT BLANEY DESIGN WILL NOT ACCEPT RESPONSIBILITY FOR VARIATIONS OR MODIFICATION OF THESE PLANS.

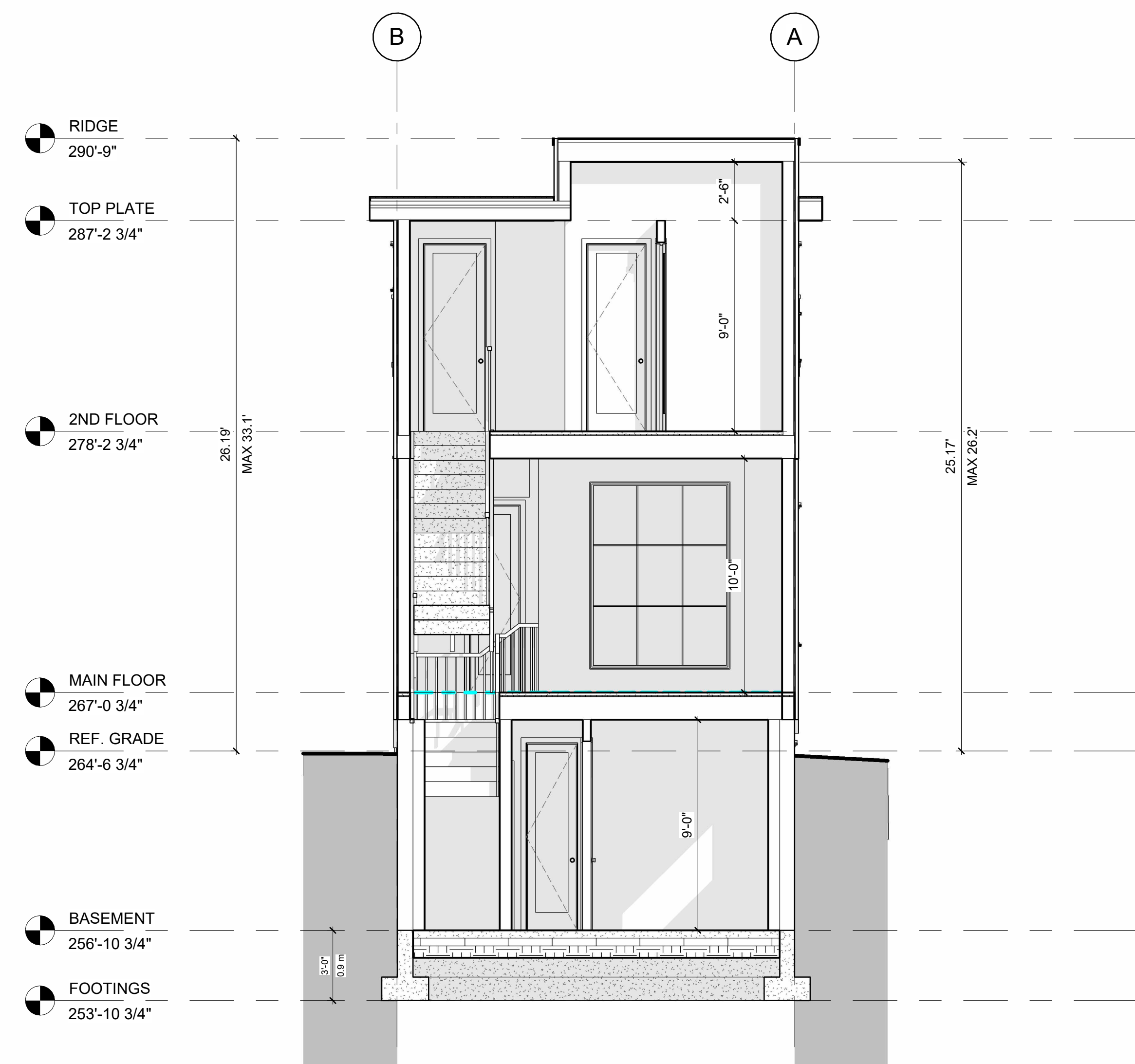
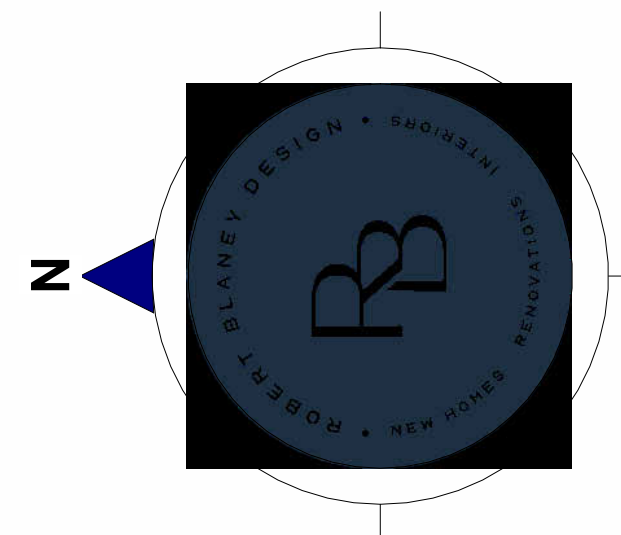

1 Section 1
1/4" = 1'-0"

W1 EXTERIOR WALL (ABOVE GRADE)

CLADDING
1/2" PURLINS OR RAIN-SCREEN SYSTEM
TYVEK SEALED & TAPED
1/2" PLYWOOD SHEATHING
2X6" STUDS @ 16" O.C
BATT INSULATION (R24)
6MIL POLY V.B
1/2" G.W.B PAINTED
AIR FILM (INTERIOR)

W2 FURRED FOUNDATION WALL

DRAINAGE MAT W/ FILTER FABRIC
2 COATS OF BITUMINOUS SEALANT
8" FOUNDATION WALL
2X6" STUDS @ 16" O.C
BATT INSULATION (R22)
6MIL POLY V.B.
1/2" G.W.B
AIR FILM (INTERIOR)

W3 FOUNDATION WALL

DRAINAGE MAT W/ FILTER FABRIC
2 COATS OF BITUMINOUS SEALANT
8" CONCRETE WALL

W4 INTERIOR WALL - 2x6"

1/2" G.W.B BOTH SIDES
2X6" STUDS @ 16" O.C

F1 FLOOR OVER CONDITIONED SPACE

FLOOR FINISH
1-1/2" CONCRETE TOPPING
3/4" T&G FLOOR SHEATHING GLUED & SCREWED
11-7/8" TJI JOISTS @ 12" O.C
1/2" G.W.B PAINTED

F2 FLOOR OVER UNCONDITIONED SPACE

FLOOR FINISH
1-1/2" CONCRETE TOPPING
3/4" T&G FLOOR SHEATHING GLUED & SCREWED
11-7/8" TJI JOISTS @ 16" O.C
SPRAY FOAM CLOSED CELL INSUL (R28)

F3 BASEMENT SLAB

FLOOR FINISH
4" REINFORCED CONCRETE SLAB
6MIL POLY V.B
3" RIGID INSULATION UNDER SLAB (R16)
6" MIN. COMPACTED GRANULAR BASE
RADON GAS VENTED

F4 PATIO SLAB/DRIVEWAY ON GRADE

4" REINFORCED CONCRETE SLAB
6" MIN. COMPACTED GRANULAR BASE

R1 FLAT ROOF

2 LAYERS TORCH ON ROOFING
3/4" ROOF SHAETHING
2X4" CROSS STRAPPING @ 16" O.C
9.5" TGI RAFTERS @ 16" O.C
BATT INSULATION (R28)
6MIL POLY V.B. TAPED AND SEALED
1/2" G.W.B PAINTED
AIR FILM (INTERIOR)

REVISIONS	
ISSUED FOR:	
REVIEW SET:	03/07/21

PROJECT:
NAME
ADDRESS 528 EAST 7TH STR
CITY NORTH VANCOUVER

SHEET:
A108

DRAWN BY:	SDP
24X36 SCALE:	1/4" = 1'-0"
PROJECT NUMBER:	Project Number
START DATE:	

DRAWING TITLE:
SECTIONS & ASSEMBLIES

COPYRIGHT RESERVED.
THIS DRAWING AND DESIGN ARE AND SHALL AT ALL TIMES REMAIN THE EXCLUSIVE PROPERTY OF ROBERT BLANEY DESIGN AND CANNOT BE USED OR REPRODUCED WITHOUT WRITTEN CONSENT. WRITTEN DIMENSIONS SHALL HAVE PRECEDENCE OVER SCALED DIMENSIONS. CONTRACTOR SHALL VERIFY AND SHALL BE RESPONSIBLE FOR ALL DIMENSIONS AND CONDITIONS ON THE JOB AND THIS OFFICE SHALL BE INFORMED OF ANY VARIATIONS FROM THE DIMENSIONS AND CONDITIONS AS SHOWN ON THIS DRAWING. CONTRACTORS SHALL ENSURE THAT ALL CONSTRUCTION WILL COMPLY TO ALL APPLICABLE BUILDING CODES. ROBERT BLANEY DESIGN WILL NOT ACCEPT RESPONSIBILITY FOR VARIATIONS OR MODIFICATION OF THESE PLANS.

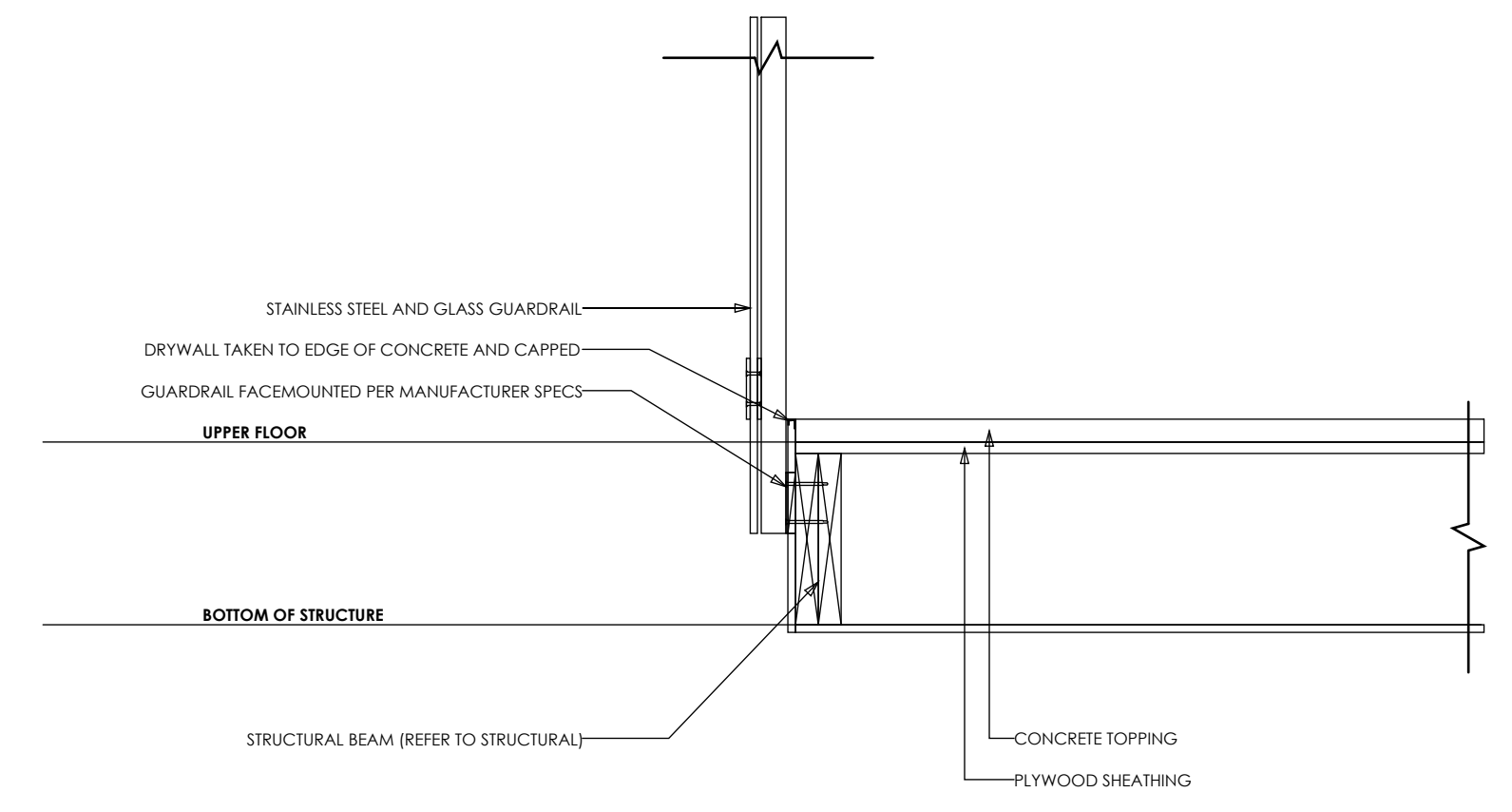
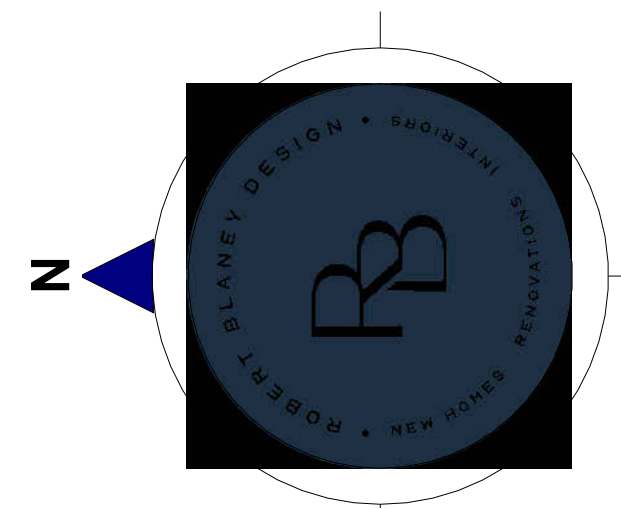

10 GUARDRAIL
1" = 1'-0"

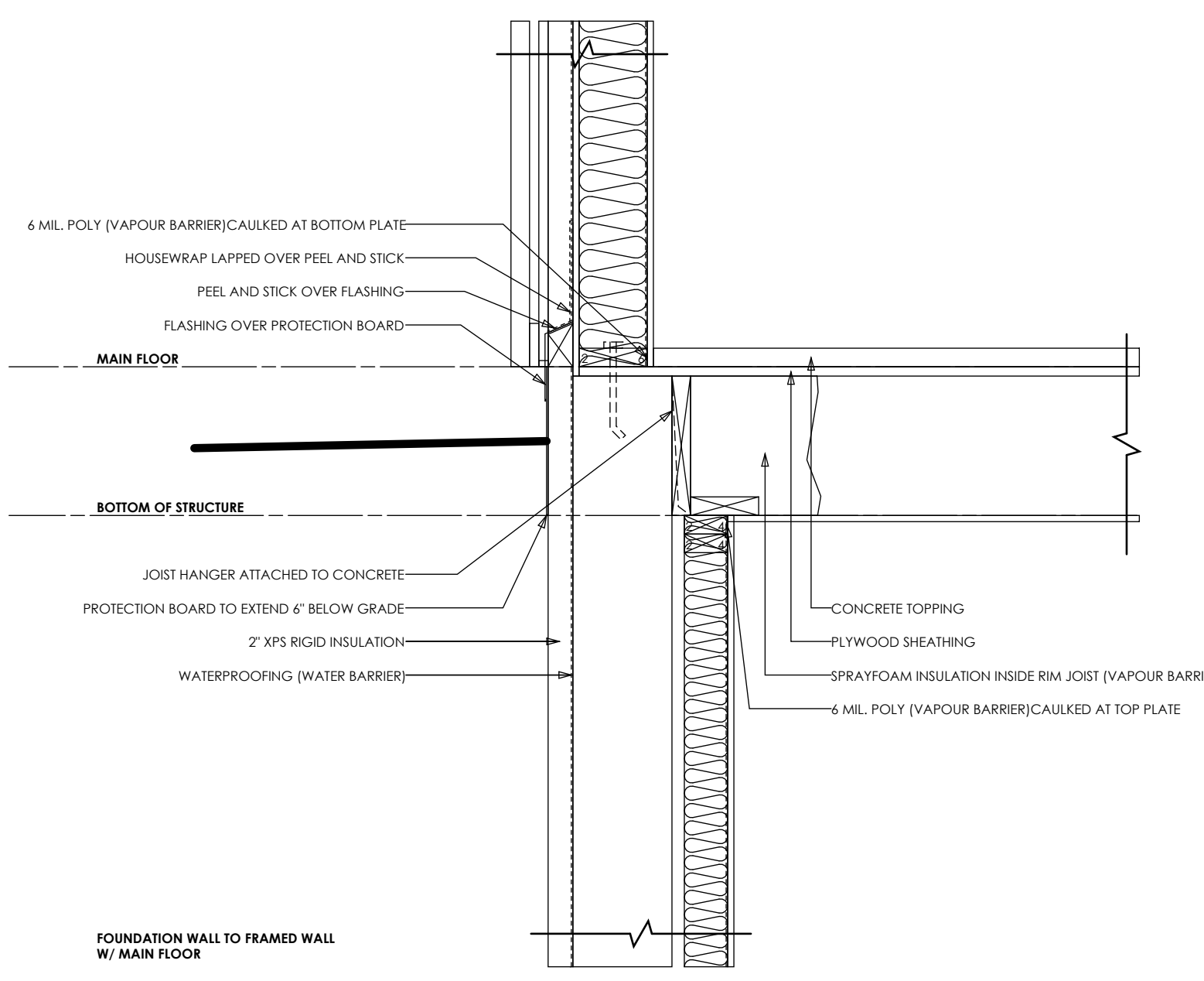

5 FOUNDATION WALL TO FRAMED WALL W/ MAIN FLOOR
1" = 1'-0"

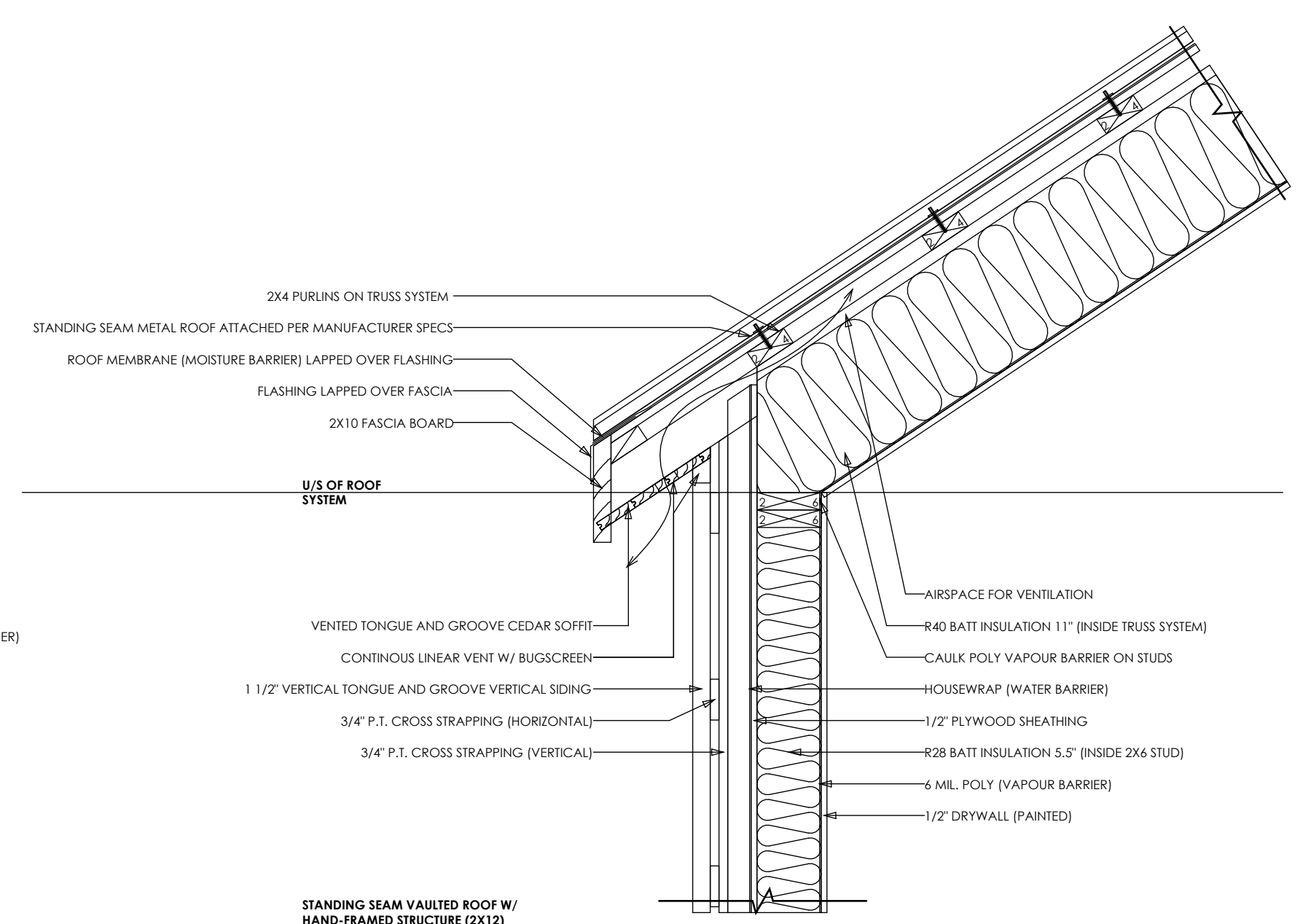

7 STANDING SEAM VAULTED ROOF W/ HAND-FRAMED STRUCTURE (2X12)
1" = 1'-0"

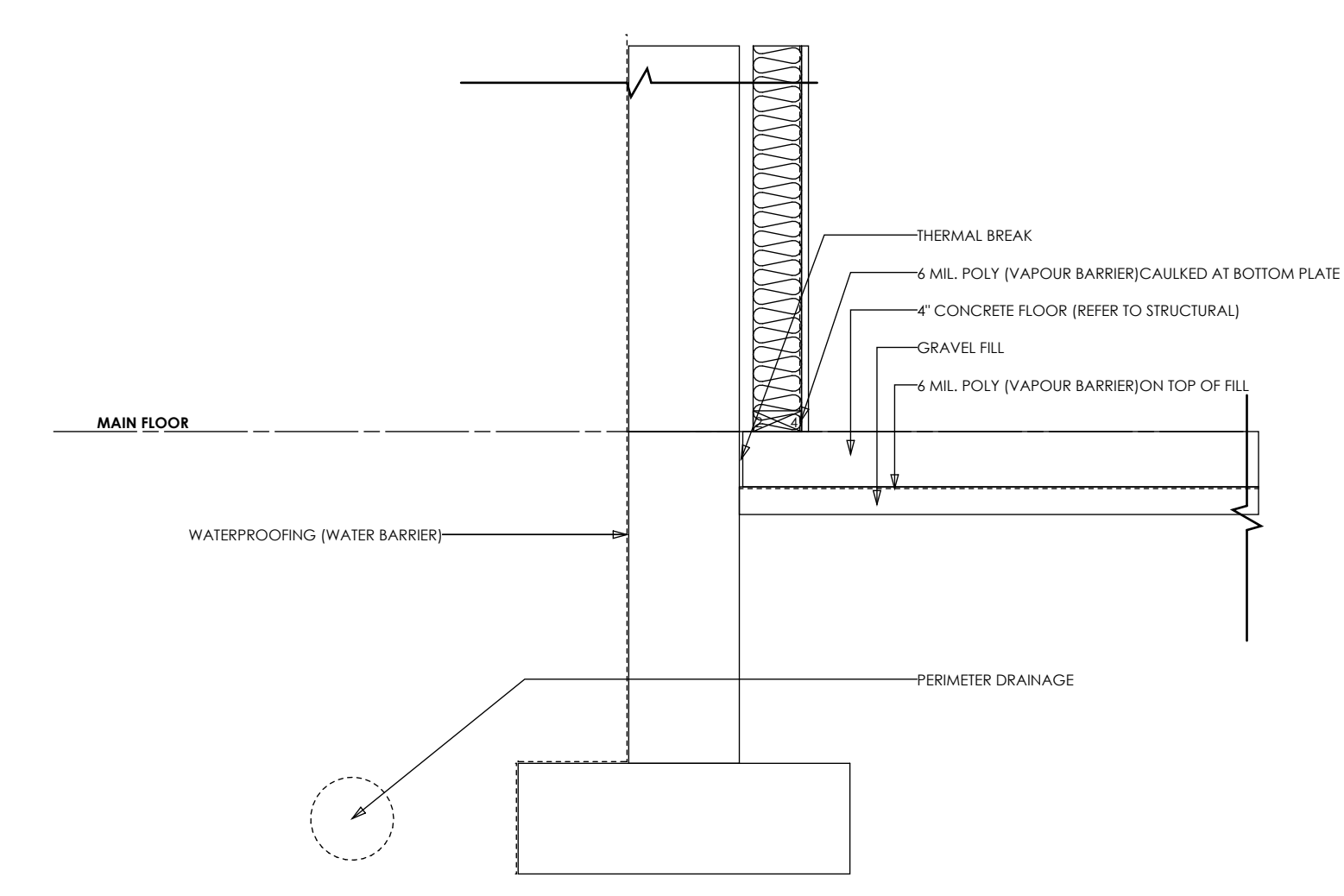

4 FOOTING TO FOUNDATION
1" = 1'-0"

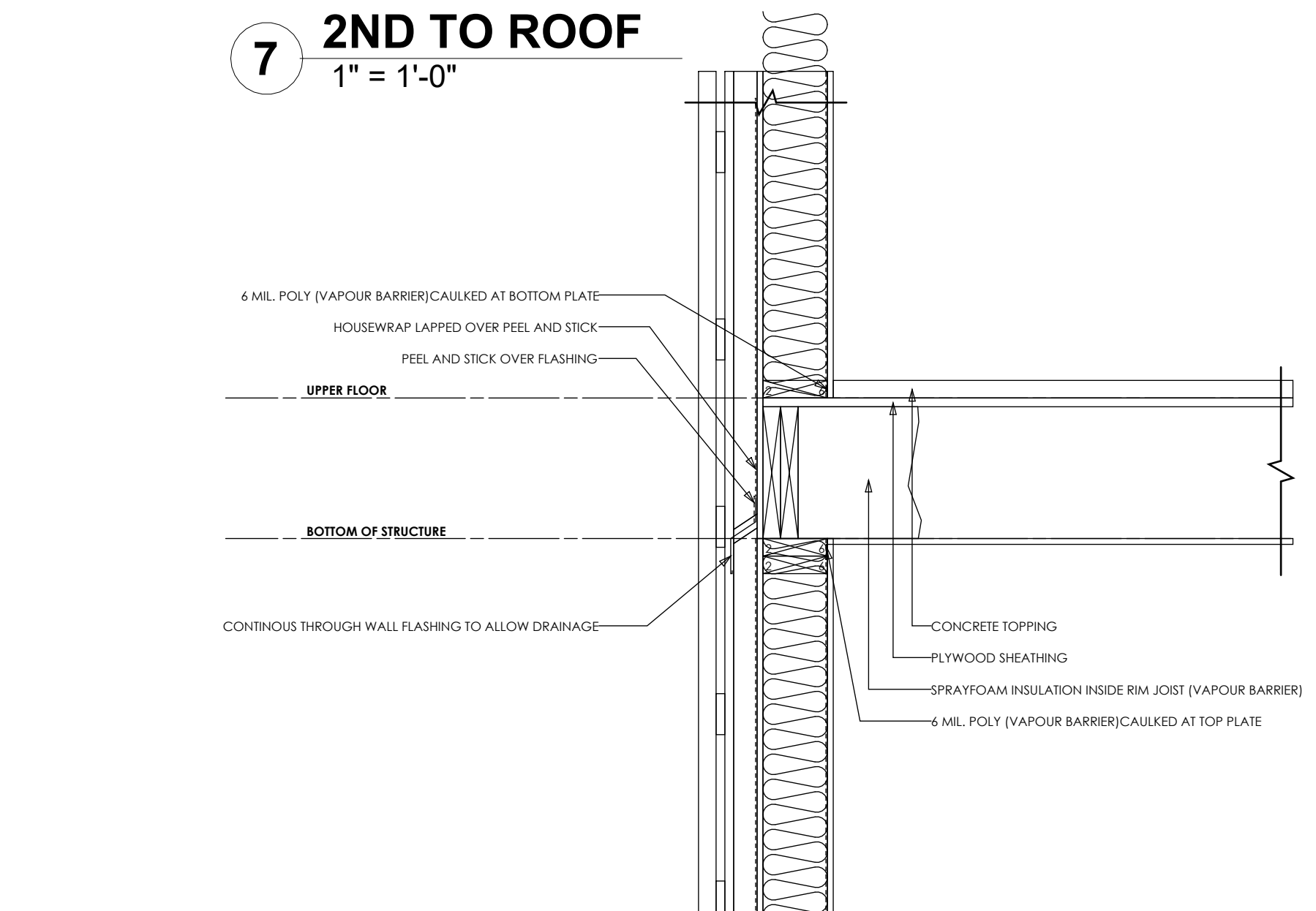

6 UPPER FLOOR TO MAIN FLOOR WALL CONNECTION
1" = 1'-0"

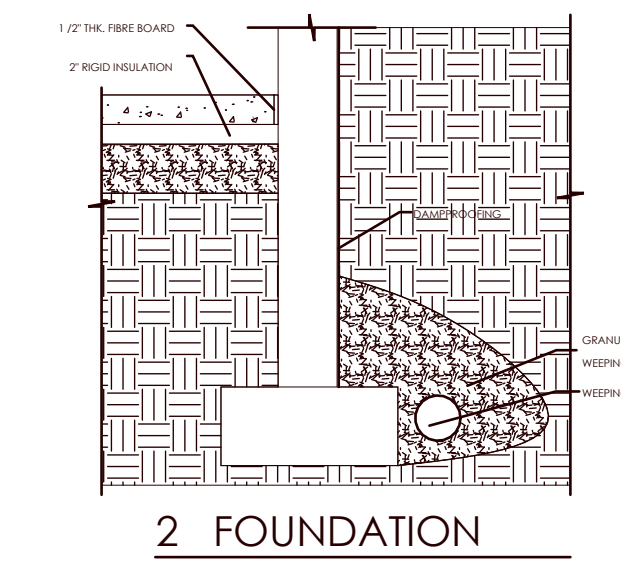

2 FOUNDATION

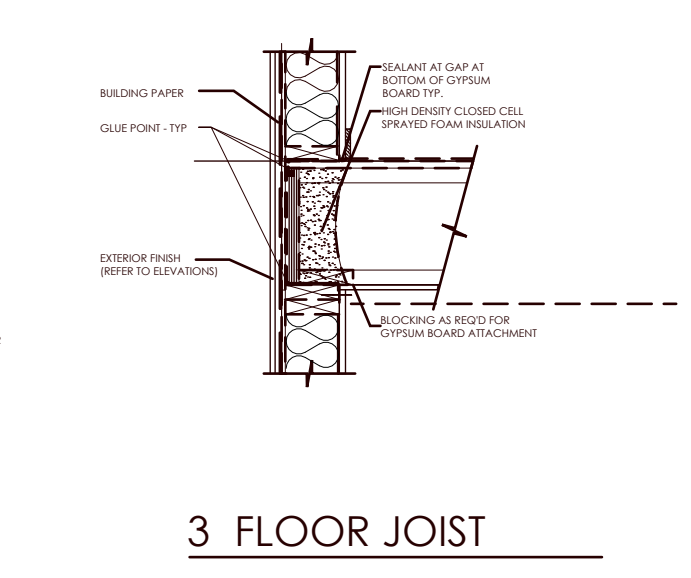

3 FLOOR JOIST

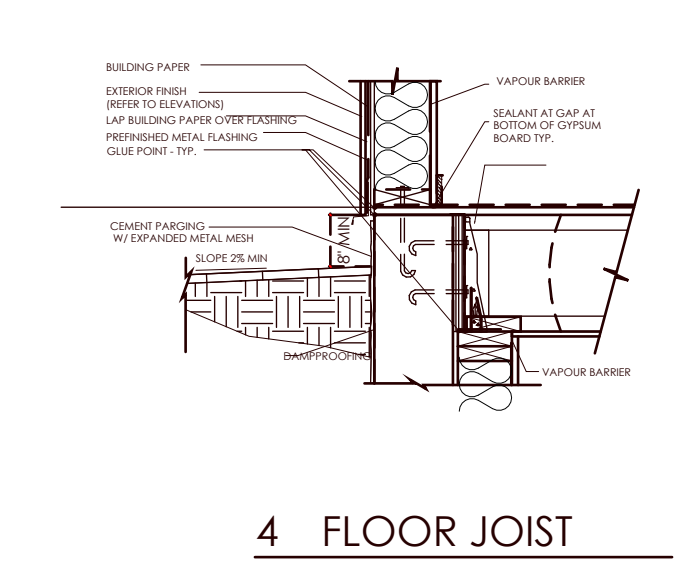

4 FLOOR JOIST

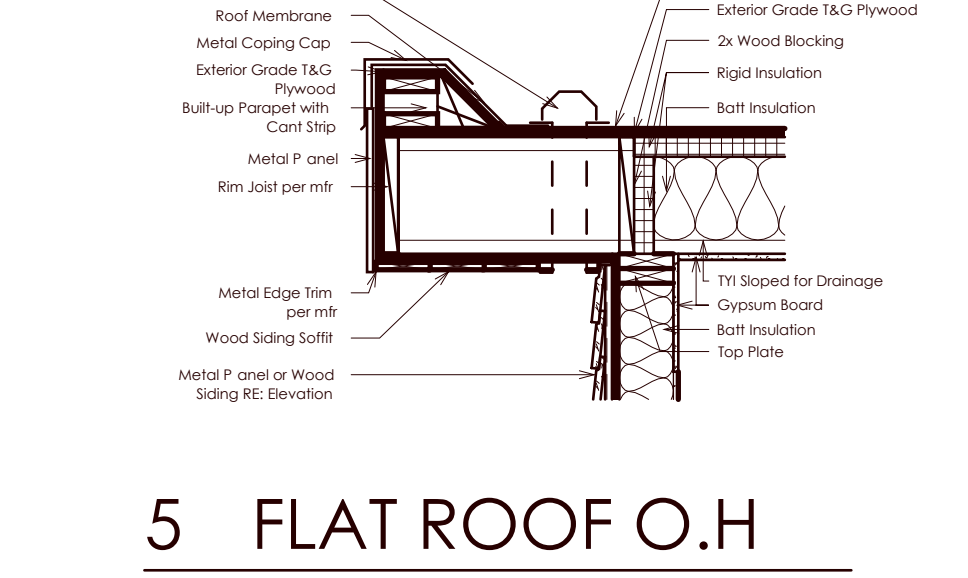

5 FLAT ROOF O.H

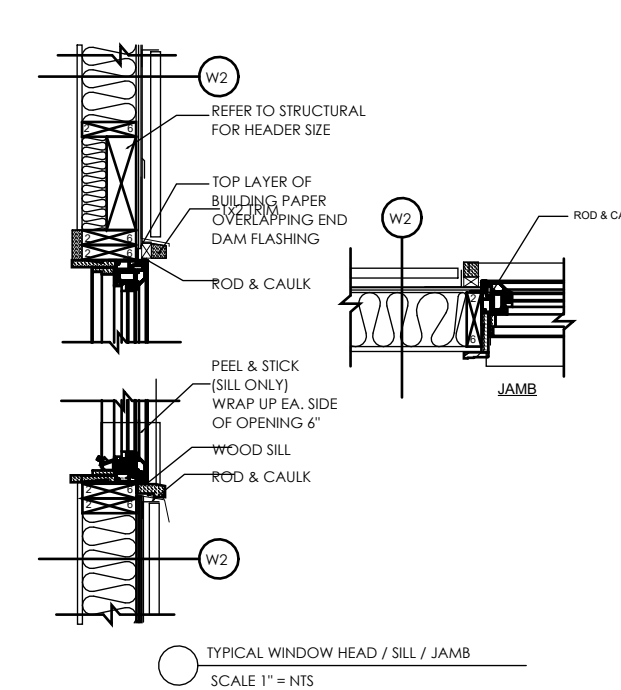

TYPICAL WINDOW HEAD / SILL / JAMB
SCALE 1" = 1/4"

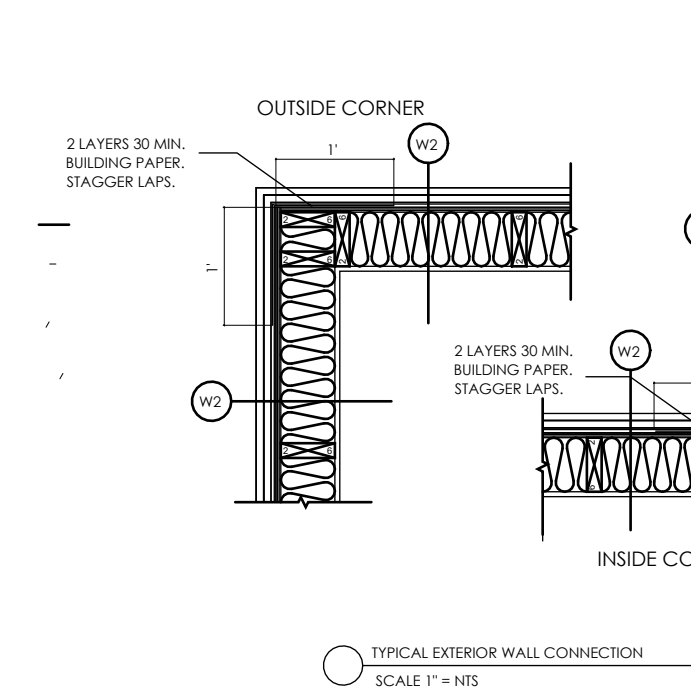

TYPICAL EXTERIOR WALL CONNECTION
SCALE 1" = 1/4"

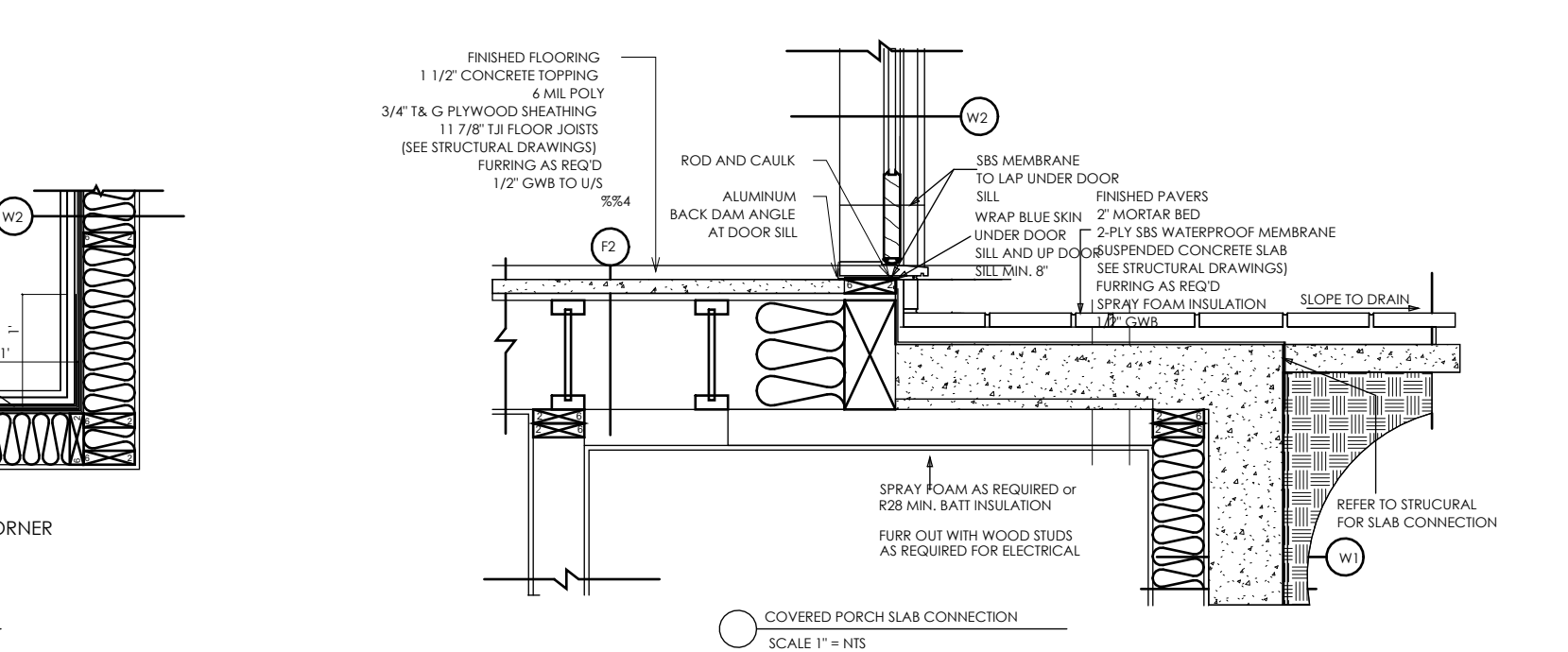

COVERED PORCH SLAB CONNECTION
SCALE 1" = 1/4"

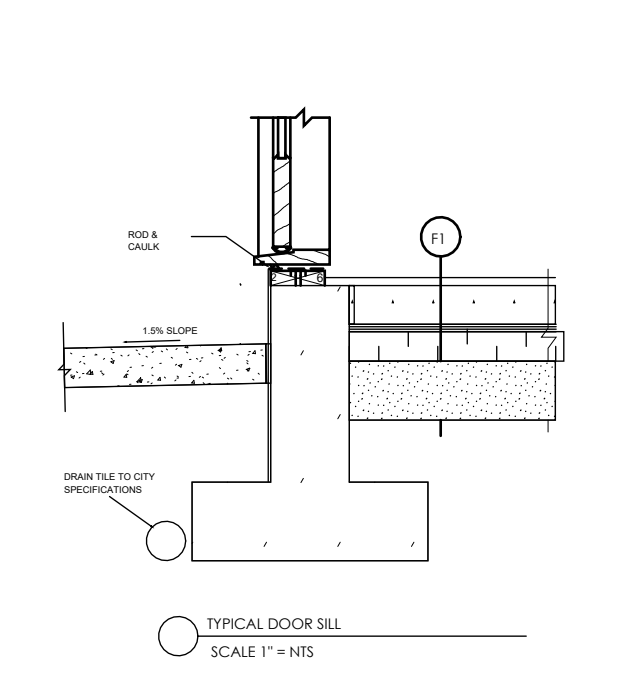

TYPICAL DOOR SILL
SCALE 1" = 1/4"

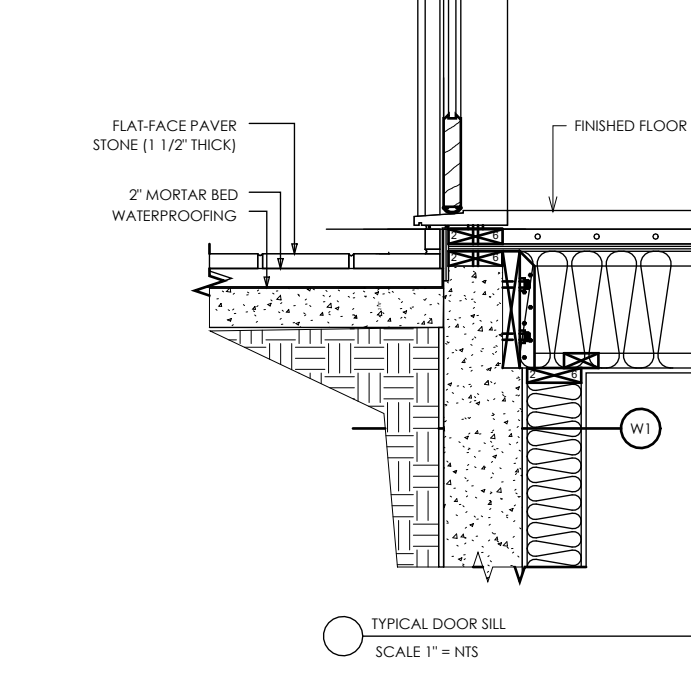

TYPICAL DOOR SILL
SCALE 1" = 1/4"

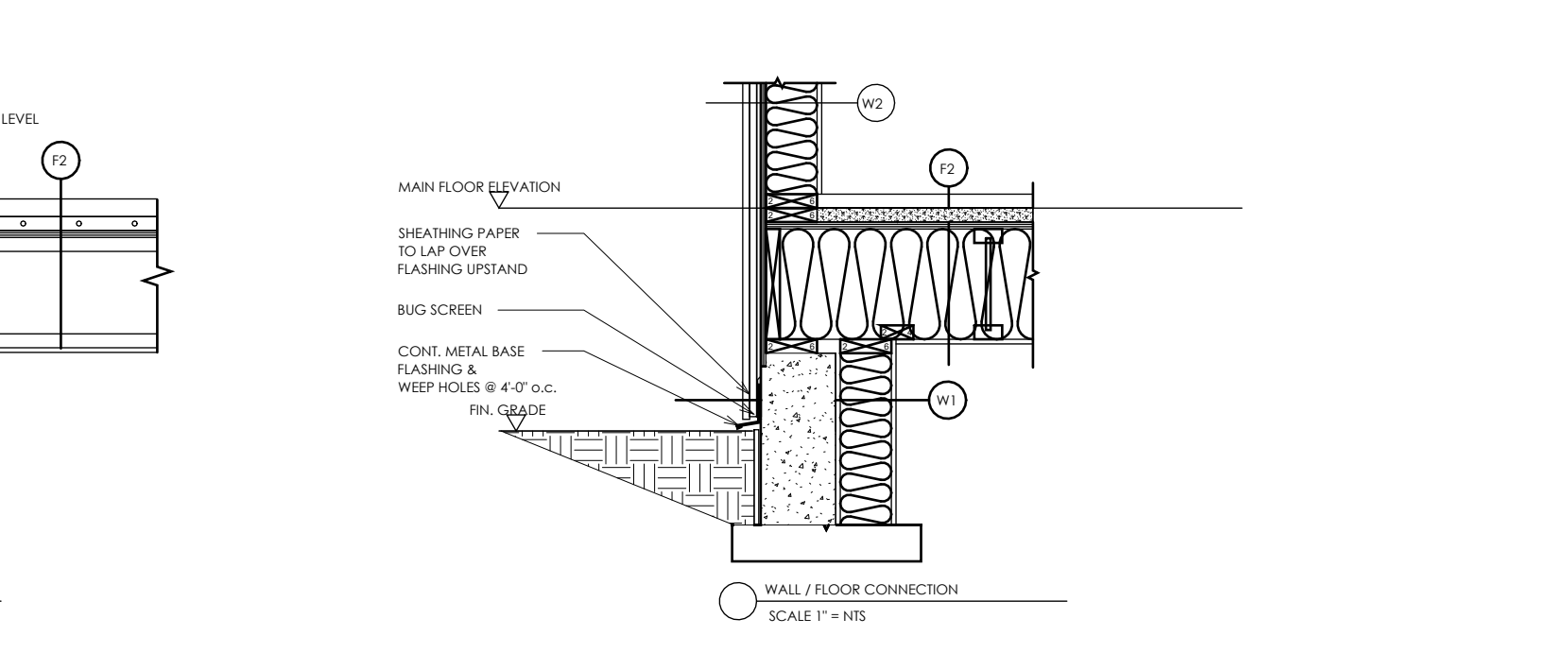

WALL / FLOOR CONNECTION
SCALE 1" = 1/4"

REVISIONS	PROJECT:
ISSUED FOR:	NAME
REVIEW SET:	ADDRESS 528 EAST 7TH STR
	CITY NORTH VANCOUVER
	DRAWING TITLE:
	DETAILS

REVISIONS	PROJECT:
ISSUED FOR:	NAME
REVIEW SET:	ADDRESS 528 EAST 7TH STR
	CITY NORTH VANCOUVER
	DRAWING TITLE:
	DETAILS

REVISIONS	PROJECT:
ISSUED FOR:	NAME
REVIEW SET:	ADDRESS 528 EAST 7TH STR
	CITY NORTH VANCOUVER
	DRAWING TITLE:
	DETAILS

REVISIONS	PROJECT:
ISSUED FOR:	NAME
REVIEW SET:	ADDRESS 528 EAST 7TH STR
	CITY NORTH VANCOUVER
	DRAWING TITLE:
	DETAILS

REVISIONS	PROJECT:
ISSUED FOR:	NAME
REVIEW SET:	ADDRESS 528 EAST 7TH STR
	CITY NORTH VANCOUVER
	DRAWING TITLE:
	DETAILS

5464 PATRICIA BAY HIGHWAY,
VICTORIA BC V8Y 2N9

(604) 626-6020
ROBERTBLANEYDESIGN@GMAIL.COM
WWW.ROBERTBLANEYDESIGN.COM



COPYRIGHT RESERVED.
THIS DRAWING AND DESIGN ARE AND SHALL AT ALL TIMES REMAIN THE EXCLUSIVE PROPERTY OF ROBERT BLANEY DESIGN AND CANNOT BE USED OR REPRODUCED WITHOUT WRITTEN CONSENT. WRITTEN DIMENSIONS SHALL HAVE PRECEDENCE OVER SCALED DIMENSIONS. CONTRACTOR SHALL VERIFY AND SHALL BE RESPONSIBLE FOR ALL DIMENSIONS AND CONDITIONS ON THE JOB AND THIS OFFICE SHALL BE INFORMED OF ANY VARIATIONS FROM THE DIMENSIONS AND CONDITIONS AS SHOWN ON THIS DRAWING. CONTRACTORS SHALL ENSURE THAT ALL CONSTRUCTION WILL COMPLY TO ALL APPLICABLE BUILDING CODES. ROBERT BLANEY DESIGN WILL NOT ACCEPT RESPONSIBILITY FOR VARIATIONS OR MODIFICATION OF THESE PLANS.

A109

DRAWN BY:	SDP
24X36 SCALE:	PROJECT NUMBER:
As indicated	Project Number
START DATE:	

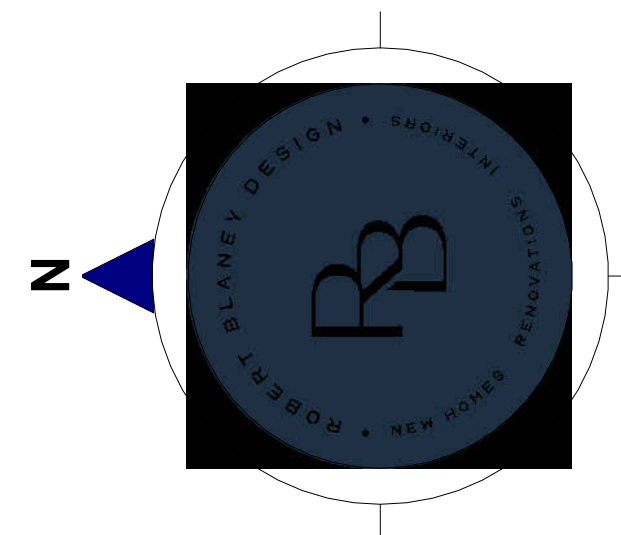

Area Schedule (Gross Building)			
Name	Area	Level	Perimeter
MAIN FLOOR	908 ft ²	MAIN FLOOR	143'-6"
BASEMENT	1075 ft ²	BASEMENT	160'-6"
2ND FLOOR	834 ft ²	2ND FLOOR	140'-9 1/2"
GARAGE	250 ft ²	GARAGE T.O SLAB	65'-6"
	3067 ft ²		

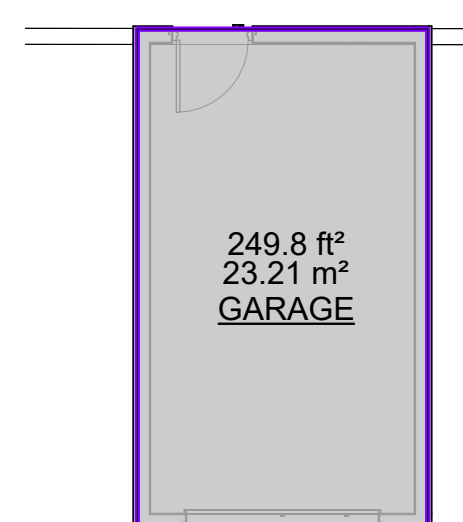

4 GARAGE
1/8" = 1'-0"

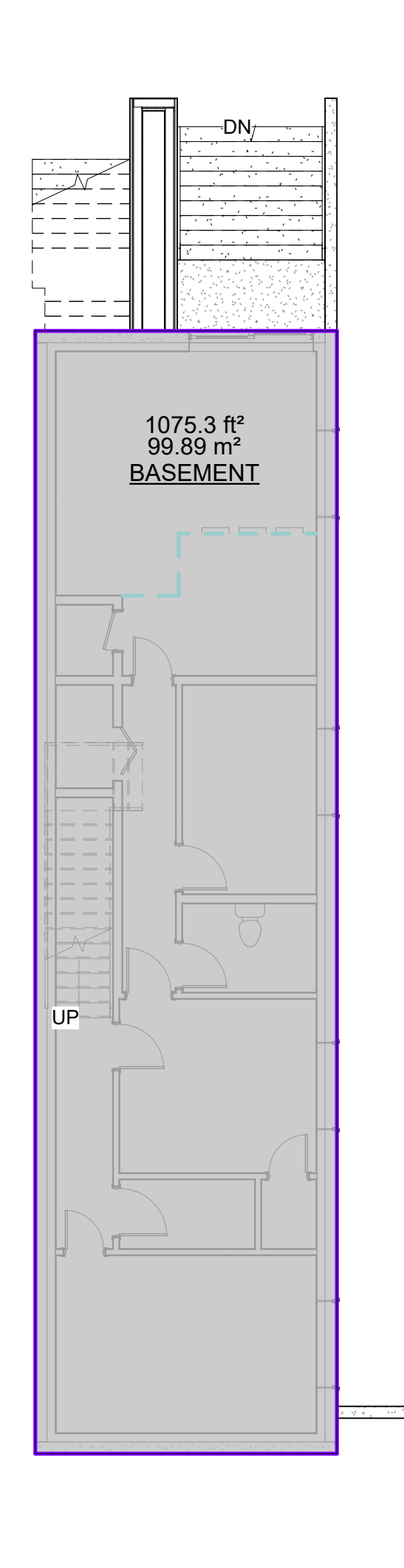

3 BASEMENT
1/8" = 1'-0"

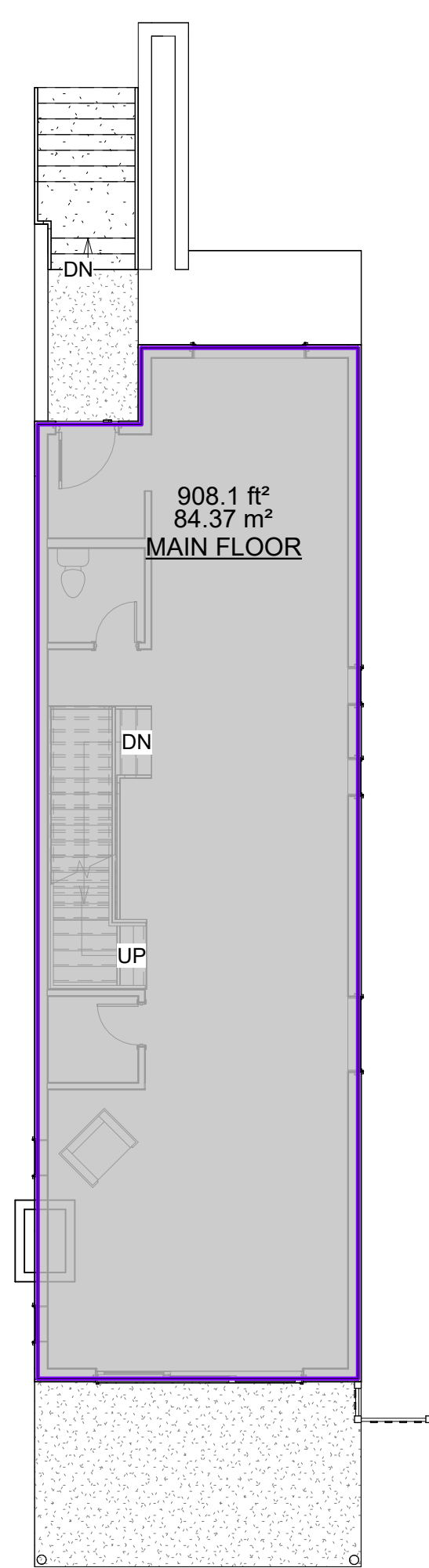

1 MAIN FLOOR
1/8" = 1'-0"

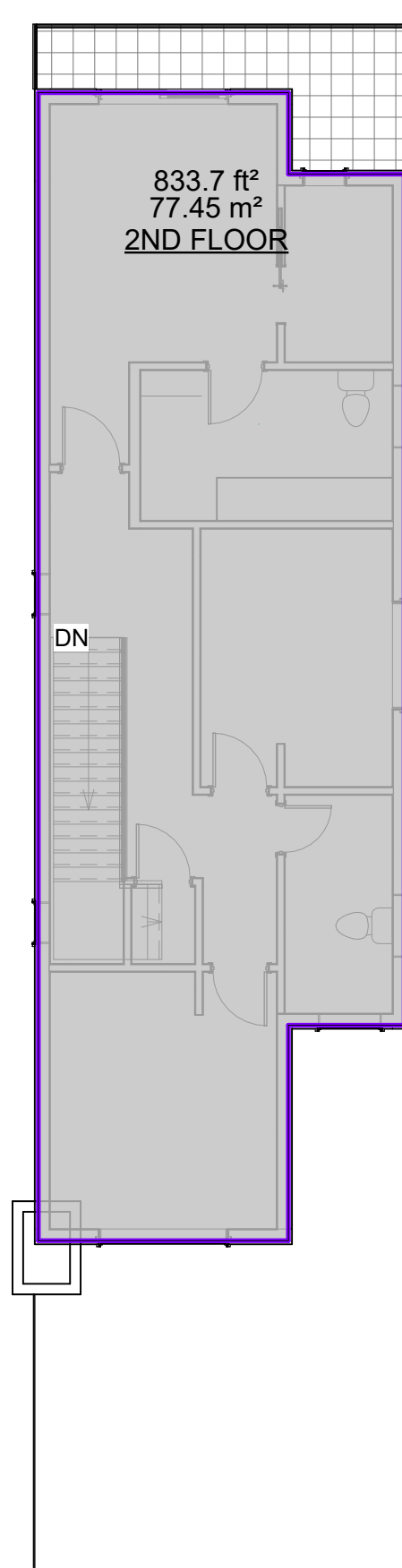

2 2ND FLOOR
1/8" = 1'-0"



5464 PATRICIA BAY HIGHWAY,
VICTORIA BC V8Y 2N9

(604) 626-6020
ROBERTBLANEYDESIGN@GMAIL.COM
WWW.ROBERTBLANEYDESIGN.COM

REVISIONS
ISSUED FOR:
REVIEW SET: 08/11/22

PROJECT:
NAME
ADDRESS 528 EAST 7TH STR
CITY NORTH VANCOUVER

DRAWING TITLE:
F.A.R

SHEET:

A110

DRAWN BY: SDP

24X36 SCALE:
1/8" = 1'-0"

START DATE:

PROJECT NUMBER:
Project Number

COPYRIGHT RESERVED.

THIS DRAWING AND DESIGN ARE AND SHALL AT ALL TIMES REMAIN THE EXCLUSIVE PROPERTY OF ROBERT BLANEY DESIGN AND CANNOT BE USED OR REPRODUCED WITHOUT WRITTEN CONSENT. WRITTEN DIMENSIONS SHALL HAVE PRECEDENCE OVER SCALED DIMENSIONS. CONTRACTOR SHALL VERIFY AND SHALL BE RESPONSIBLE FOR ALL DIMENSIONS AND CONDITIONS ON THE JOB AND THIS OFFICE SHALL BE INFORMED OF ANY VARIATIONS FROM THE DIMENSIONS AND CONDITIONS AS SHOWN ON THIS DRAWING. CONTRACTORS SHALL ENSURE THAT ALL CONSTRUCTION WILL COMPLY TO ALL APPLICABLE BUILDING CODES. ROBERT BLANEY DESIGN WILL NOT ACCEPT RESPONSIBILITY FOR VARIATIONS OR MODIFICATION OF THESE PLANS.

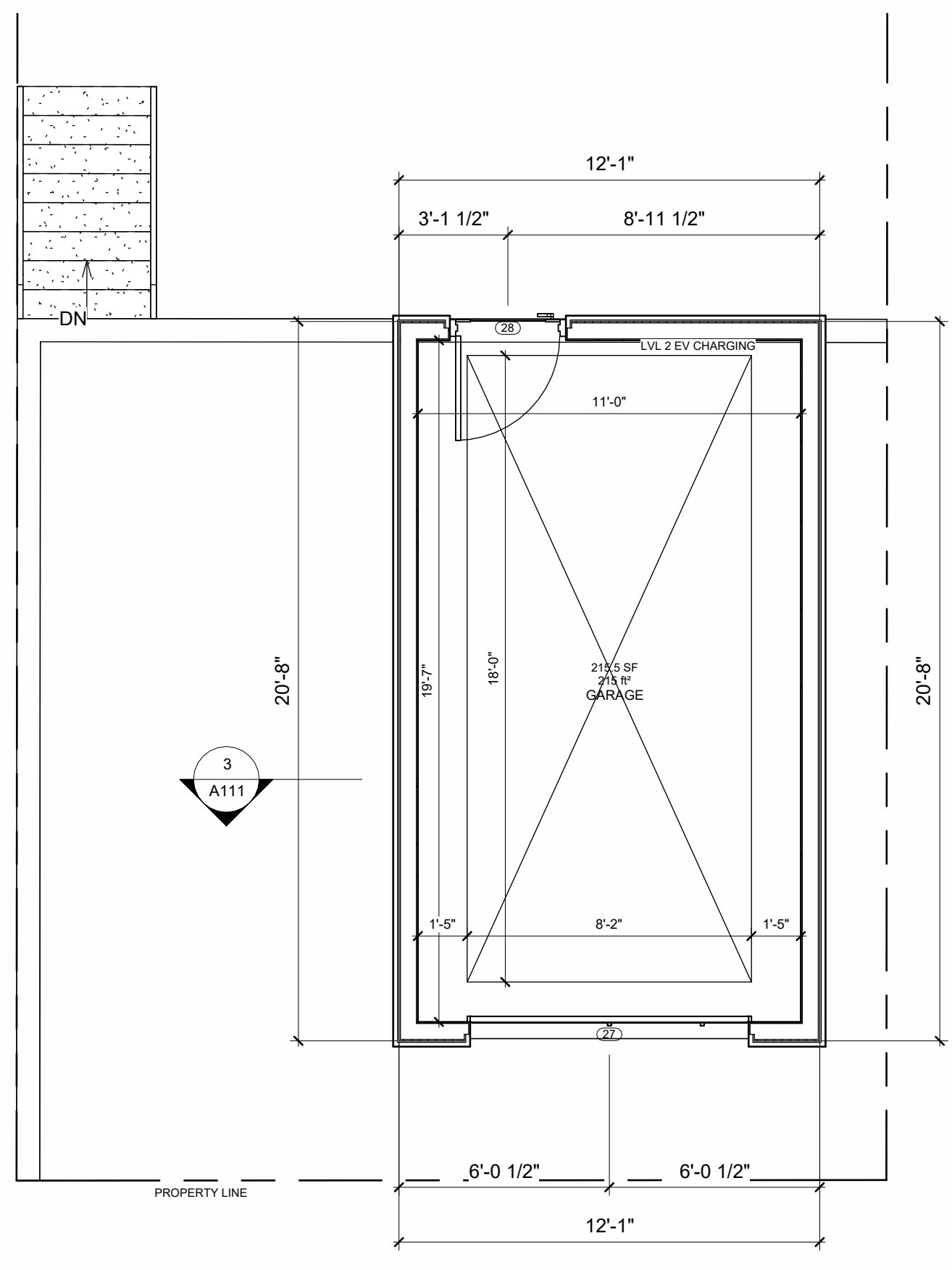

1 GARAGE FLOOR PLAN
1/4" = 1'-0"

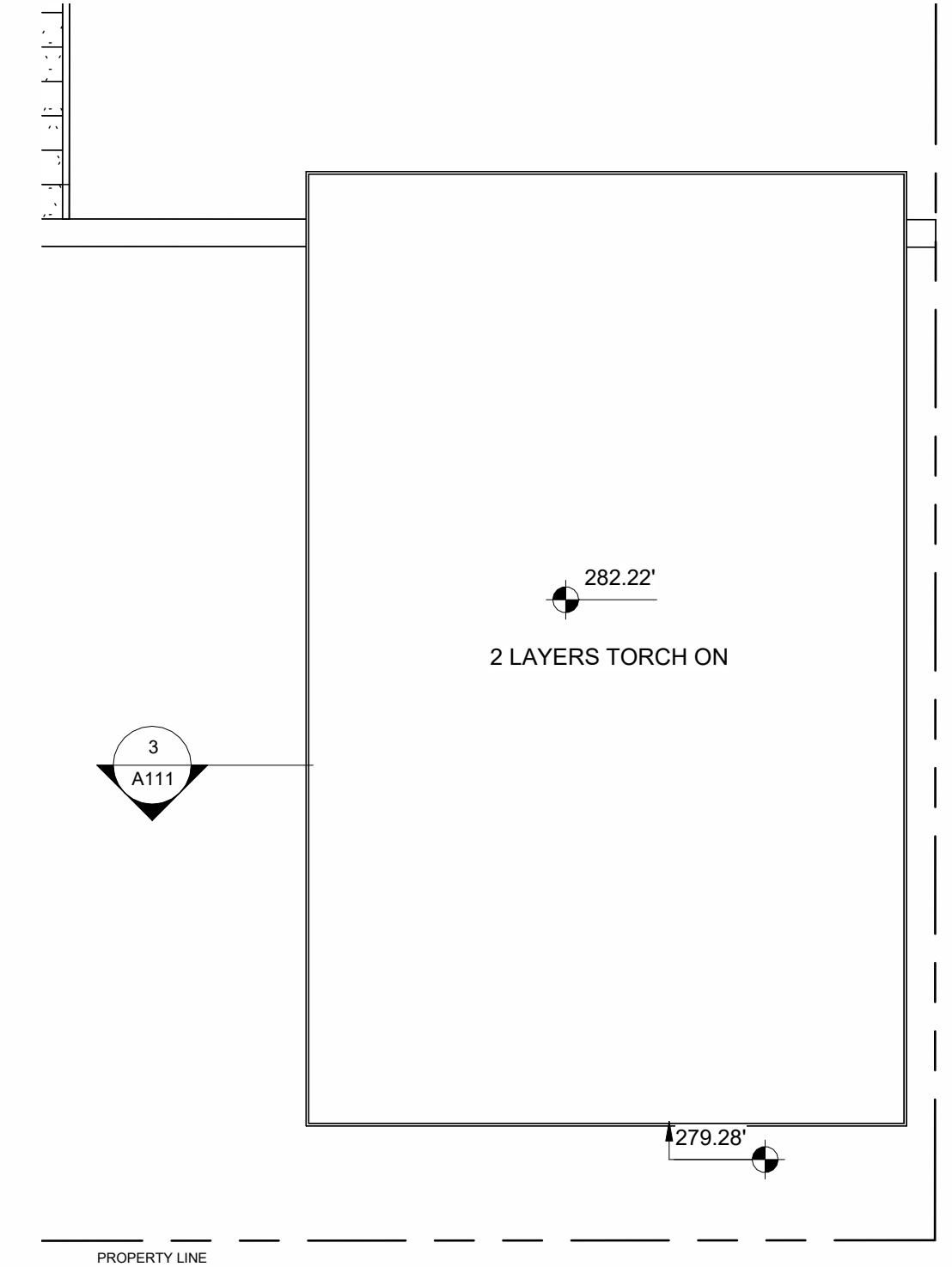

2 GARAGE ROOF PLAN
1/4" = 1'-0"

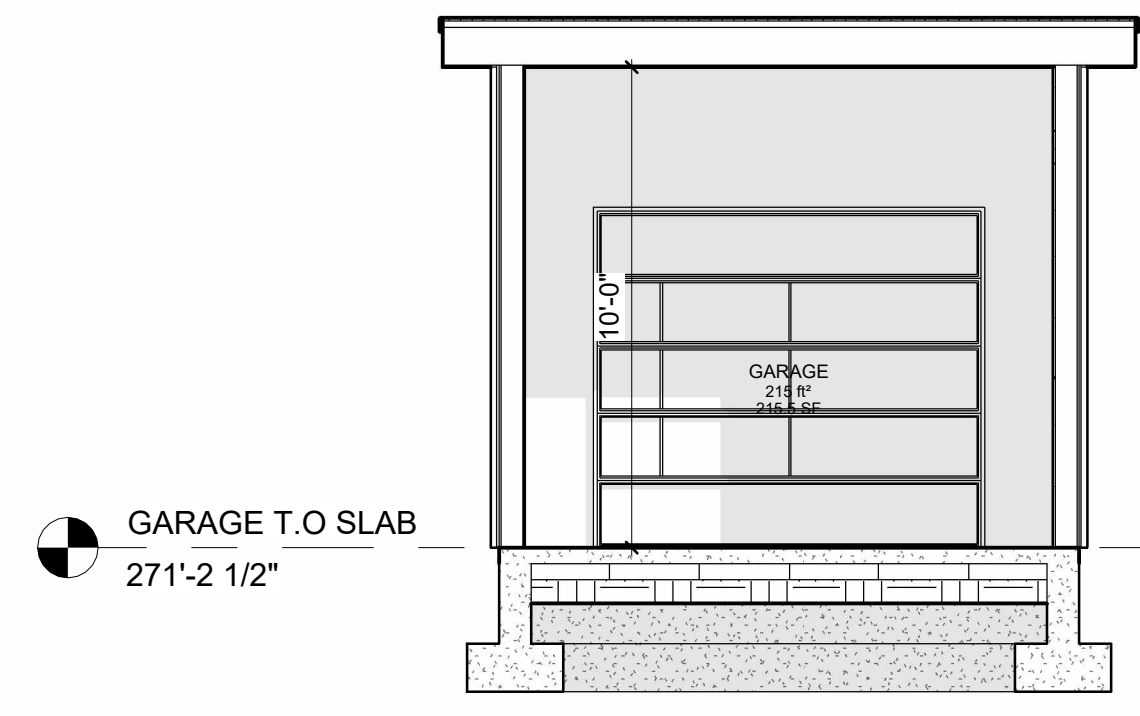

3 GARAGE SECTION
1/4" = 1'-0"

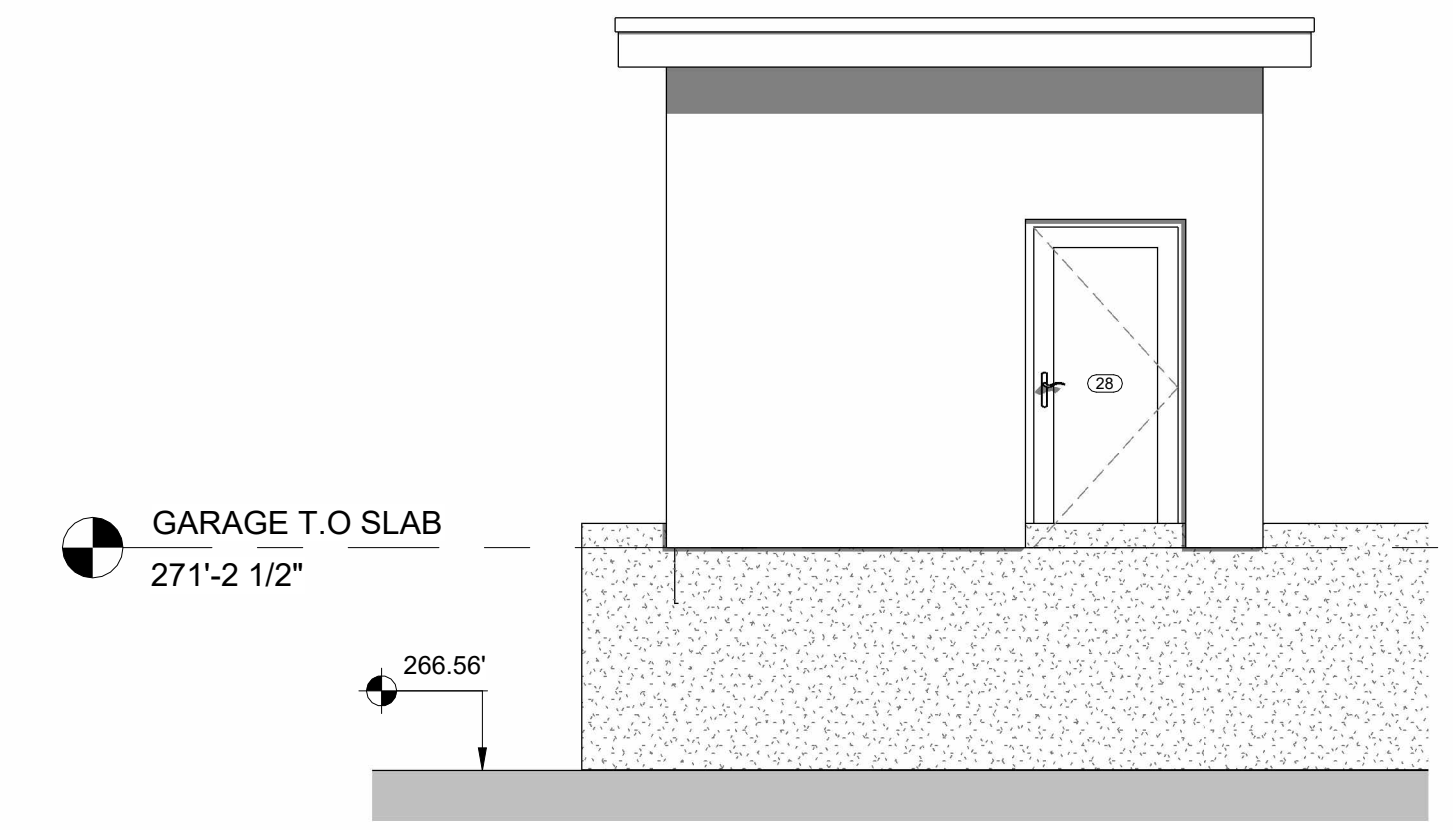

6 GARAGE - SOUTH
1/4" = 1'-0"

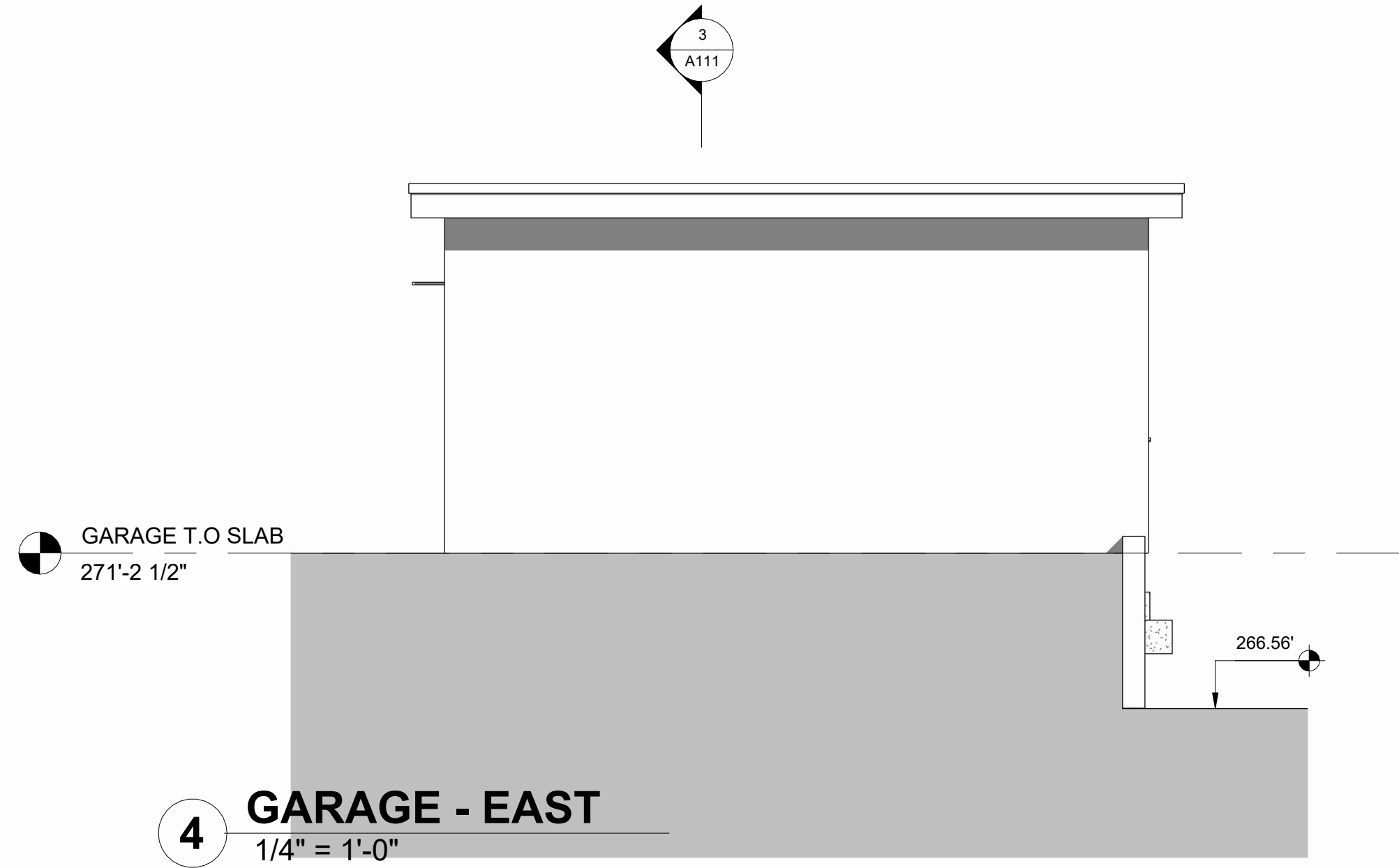

4 GARAGE - EAST
1/4" = 1'-0"

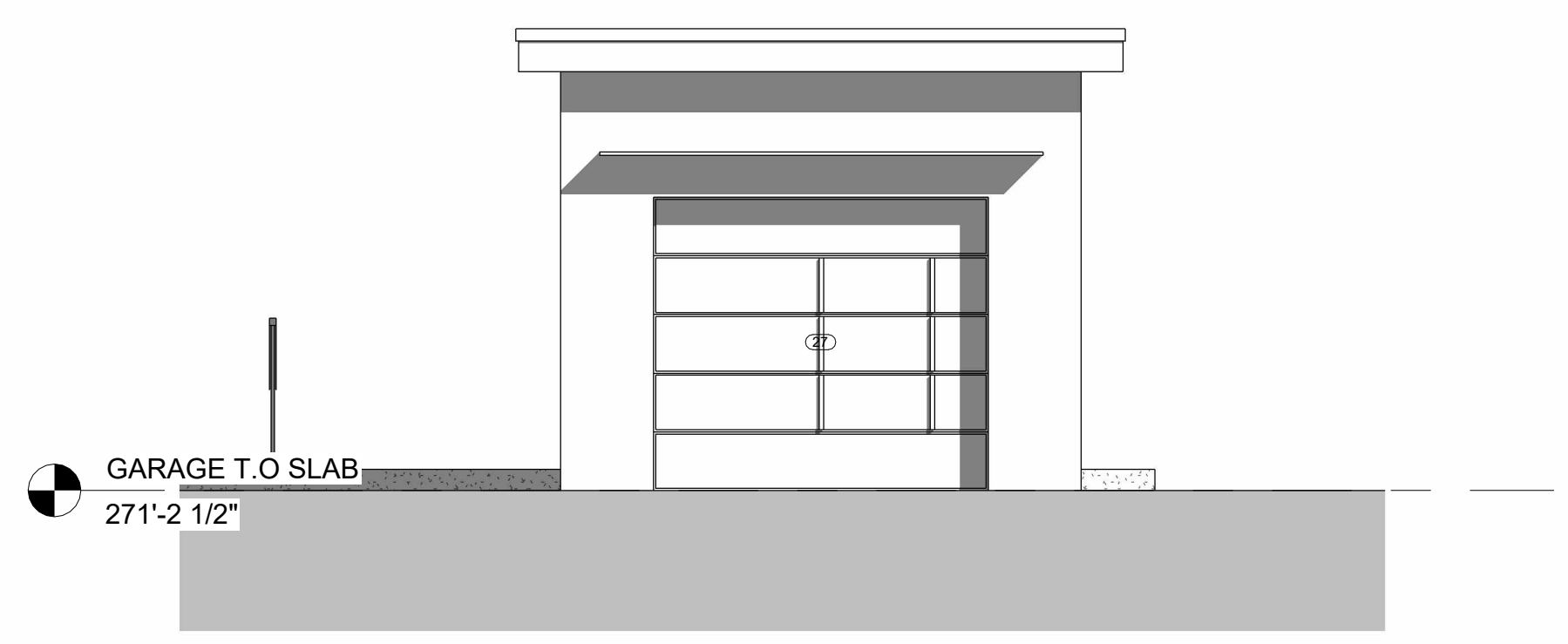

5 GARAGE - NORTH
1/4" = 1'-0"



7 GARAGE - WEST
1/4" = 1'-0"